

**KW2G
Eco-POWER METER
User's Manual**

Cautions for Your Safety

Read the manual carefully before installing, running and maintenance for proper operation. Before using, master the knowledge of the equipment, safety information and all of other notes.

This manual uses two safety flags to indicate different levels of danger.



WARNING

A handling error could cause serious physical injury to an operator and in the worst case could even be fatal.

- Always take precautions to ensure the overall safety of your system, so that the whole system remains safe in the event of failure of this product or other external factor.
- Do not use this product in areas with inflammable gas. It could lead to an explosion.
- Exposing this product to excessive heat or open flames could cause damage to the lithium battery or other electronic parts.



CAUTION

A handling error could cause serious physical injury to an operator or damage to the equipment.

- To prevent abnormal exothermic heat or smoke generation, use this product at the values less than the maximum of the characteristics and performance that are assured in these specifications.
- Do not dismantle or remodel the product. It could lead to abnormal exothermic heat or smoke generation.
- Do not touch the terminal while turning on electricity. It could lead to an electric shock.
- Use the external devices to function the emergency stop and interlock circuit.
- Connect the wires or connectors securely. The loose connection might cause abnormal exothermic heat or smoke generation.
- Do not allow foreign matters such as liquid, flammable materials, metals to go into the inside of the product. It might cause exothermic heat or smoke generation.
- Do not undertake construction (such as connection and disconnection) while the power supply is on.
- Do not use at secondary side circuit of inverter. It might cause exothermic heat or damage.

Copyright and trademark

- Panasonic Electric Works, Co., Ltd. owns the copyright of this manual.
- We stiffly refuse the reproduction of without permission from this manual.
- Modbus Protocol is a communication protocol that the Modicon Inc. developed for PLC.
- Other company names and the product names are the trademarks or registered trademarks of each company.

Introduction

Thank you very much indeed for purchasing
“KW2G Eco-POWER METER”.

In this manual, we explain the usage of
“KW2G Eco-POWER METER” in detail.

Please use it correctly after understanding the content
enough.

Table of Contents

Chapter 1 Unit's Outline	1
1.1 Unit's Name and Model Numbers	1
1.1.1 Main unit	1
1.1.2 Option	1
1.2 Measurement items	2
Chapter 2 Parts Name and Working	3
2.1 Parts Names	3
2.2 Key's Functions	4
Chapter 3 Installation	5
3.1 Measured-circuit	5
3.2 Connection between the main unit and the expansion unit	5
3.3 DIN rail mounting	6
3.4 Terminal arrangement	7
3.5 Wiring Diagram	8
3.5.1 In case of using only main unit	8
3.5.2 In case of using main unit and connected expansion units	10
3.6 How to attach the Current Transformer (CT)	12
3.7 For input connection	13
3.8 For Output connection	14
3.9 RS485 communication	14
3.10 Low Voltage Directive	15
Chapter 4 Settings	16
4.1 Operation procedure	16
4.2 Setting Mode Explanation	20
4.2.1 MODE 1	20
4.2.2 Mode 2	26
4.2.3 Mode 3	27
4.2.4 Mode 4	29
Chapter 5 Various Functions	30
5.1 LOCK mode	30
5.2 Pulse output function	30
5.2.1 Output depends on integrated electric power	30
5.2.2 Instantaneous electric power alarm	30
5.2.3 Current alarm	30
5.2.4 Stand-by power alarm	30
5.2.5 Output depends on count value	30
5.3 Counter function	31
Chapter 6 Display of each Value	32
6.1 Working of Monitor Display	32
6.2 Display of each measurement value (Common to main unit and expansion unit)	35
6.2.1 Integrated electric power	35
6.2.2 Instantaneous electric power	36
6.2.3 Current	37
6.2.4 Voltage	38
6.2.5 Electricity Charge	39
6.2.6 Carbon dioxide conversion value	39
6.2.7 Power factor	40
6.2.8 Frequency	40
6.2.9 Counter	41
6.3 Other indication	41
6.3.1 Indication while communication	41

Chapter 7 Communication.....	42
7.1 Communication Procedures	42
7.2 Communication timing	42
7.3 MEWTOCOL Communication.....	43
7.3.1 Overview of MEWTOCOL-COM (RS485, USB).....	43
7.3.2 Data Register List (MEWTOCOL)	44
7.3.3 Error Codes	47
7.3.4 Command.....	47
7.4 MODBUS (RTU) Communication	49
7.4.1 Overview of MODBUS (RTU).....	49
7.4.2 Data Register List (MODBUS communication)	52
Chapter 8 How to update the firmware.....	56
8.1 Prepare Eco-POWER METER to update	56
8.2 Update the firmware using KW Version Upgrade Tool.....	56
Chapter 9 Specifications.....	61
9.1 Main unit, Expansion unit.....	61
9.2 Measurement.....	62
9.3 Output Specifications	63
9.4 Communication Specifications.....	64
9.5 Applicable standard	64
9.6 Dedicated Current Transformer Specifications.....	65
9.7 Self-diagnostic function.....	65
9.8 Power Failure Memory.....	65
Chapter 10 Mounting.....	66
10.1 Dimensions	66
10.1.1 Main unit.....	66
10.1.2 Expansion unit.....	67
10.1.3 Dedicated CT	68

Cautions before using

■ Installation environment

◇ Do not use the Unit in the following environments.

- Where the unit will be exposed to direct sunlight and where the ambient temperature is outside the range of -10 to 50 °C.
- Where the ambient humidity is outside the range of 30 to 85 % RH (at 20°C, non-condensing) and where condensation might occur by sudden temperature changes
- Where inflammable or corrosive gas might be produced
- Where the unit will be exposed to excessive airborne dust or metal particles
- Where the unit will be exposed to water, oil or chemicals
- Where organic solvents such as benzene, paint thinner, alcohol, or strong alkaline solutions such as ammonia or caustic soda might adhere to the product
- Where direct vibration or shock might be transmitted to the product, and where water might wet the product
- Where the place near high-voltage cable, high-voltage device, power line, power device.
- Where the place near a machinery with transmission function such as amateur radio.
- Where the place near a machinery which occurs the big switching surge

◇ Please use the Unit according to the specifications described in this manual. Otherwise, it may malfunction or cause fire and an electric shock.

- Connect to the power supply in compliance with the rating.
- Refer to the wiring diagram to ensure proper wiring for the power supply, input and output.
- Do not perform wiring or installation with a live line. It may also lead to circuit burnout or fire by way of the secondary CT side opening.

■ Installation

- Eco-POWER METER is designed to be used in a control panel.
- The power supply terminal and voltage input terminal of the main unit is common. Therefore if additional noise affects the power supply line, incorrect measurements may result.
- Installation and wiring must be performed by expert personnel for electrical work or electric piping.
- Do not add an excess power to the display. It might break the inner liquid crystal.

■ As to measurement

- If there is some distortion by harmonic or waveform, it may not measure correctly. Please check with the actual system before adopting it.
- It might not measure an instantaneous current such as an inrush current or an welding machine.
- When measuring the below loads, it might not satisfy with the accuracy guarantee.
 - Out of rating current, Load with low power factor,
 - Load with winding current, Load with ferromagnetic field
- It takes time to update monitor display when many units are connected. However, data update cycle is not changed.
- The unevenness will be large when using outside of rated frequency. In this case, set the shift average frequency big.

■ Static electricity

- Discharge static electricity touching the grounded metal etc. when you touch the unit.
- Excessive static electricity might be generated especially in a dry place.

■ Cleaning

- Wipe dirt of the main unit with soft cloth etc. When thinner is used, the unit might deform or be discolored.

■ Power supply

- Connect a breaker to the voltage input part for safety reasons and to protect the device.
The breaker that connects to the voltage input part must arrange at the position easily reached, and display shows it is the breaker of the equipment.
- Do not turn on the power supply or input until all wiring is completed.

■ Before power on

Please note the following points when turning on power at the first time.

- Confirm there are neither wiring rubbish nor especially an electrical conduction when installed.
- Confirm neither the power supply wiring, the I/O wiring nor the power-supply voltage are wrong.
- Tighten the installation screw and the terminal screw surely.
- Use an electric wire applicable to the rated current.

Chapter 1 Unit's Outline

KW2G Eco-POWER METER is the wattmeter that can measure electric power, current, voltage, PF and so on with combination of one main unit and expansion units (power measurement).

By connecting main unit and expansion unit (power measurement), it can measure up to 8-circuit (16-circuit of single-phase two-wire system).

1.1 Unit's Name and Model Numbers

1.1.1 Main unit

Product name	Model No.	Connecting method	
Main unit	AKW2010G	Power supply terminal (Voltage input terminal)	M3.5+ screw
		Pulse I/O terminal RS485 communication terminal	M3+ screw
		Current transformer (CT)	Connector
		USB communication	Connector
Expansion unit (Power measurement)	AKW2110G	Current transformer (CT)	Connector * Connect to main unit with the connector.

1.1.2 Option

Product name	Rated primary current	Model No
Dedicated current transformer for 5A/50A	5A / 50A	AKW4801C
Dedicated current transformer for 100A	100A	AKW4802C
Dedicated current transformer for 250A	250A	AKW4803C
Dedicated current transformer for 400A	400A	AKW4804C

Product name	Model No	Remarks
Mounting rail	AT8-DLA1	----
Fastening plate	ATA4806	----
Extension cable for CT 1m	AKW4701	----
Extension cable for CT 3m	AKW4703	----
Extension cable for CT 5m	AKW4705	----
CT trunk cable 1m	AKW4811 *1	Required when using 600A CT

1.2 Measurement items

Item		Unit	Data range
Integrated electric power (Active) *2		kWh/ MWh	(6-digit display) 0.00 to 9999.99MWh (9-digit display) 0.00 to 9999999.99kWh
Instantaneous electric power	Active *1	kW	-9999.99 to 0.000 to 9999.99
	Reactive *5	kvar	-9999.99 to 0.00 to 9999.99
	Apparent	kVA	0.00 to 9999.99
Current	R-current	A	0.000 to 6000.00
	N/S-current	A	0.000 to 6000.00 (calculated value)
	T-current	A	0.000 to 6000.00
Voltage	R(RS)-voltage	V	0.0 to 9999.9
	S(RT)-voltage	V	0.0 to 9999.9 (calculated value)
	T(TS)-voltage	V	0.0 to 9999.9
Electricity charge *3			0.00 to 999999
Conversion value	Carbon dioxide	kg-CO ₂	0.00 to 999999
Power Factor *1			-1.00 to 1.00 (without identify leading phase and lagging phase)
Frequency	Hz		47.5 to 63.0
Pulse counter *4			0 to 999999

* 1 KW2G can measure regeneration electric power.

While detecting regeneration electric power, minus is displayed on instantaneous active power and power factor.

* 2 Integrated electrical power is not integrated (not subtracted) when detecting regeneration power.

* 3 Eco-POWER METER is designed chiefly to manage saving energy.

It is neither intended nor can it be legally used for billing.

* 4 Displayed digit of pulse counter differs according to the pre-scale set by pre-scale setting mode.

* 5 It determines pulse or minus of instantaneous reactive power by the input measuring voltage and the input measuring current.

When harmonics or a wave pattern is warped, it may not determine correctly.

Chapter 2 Parts Name and Working

2.1 Parts Names

Front view

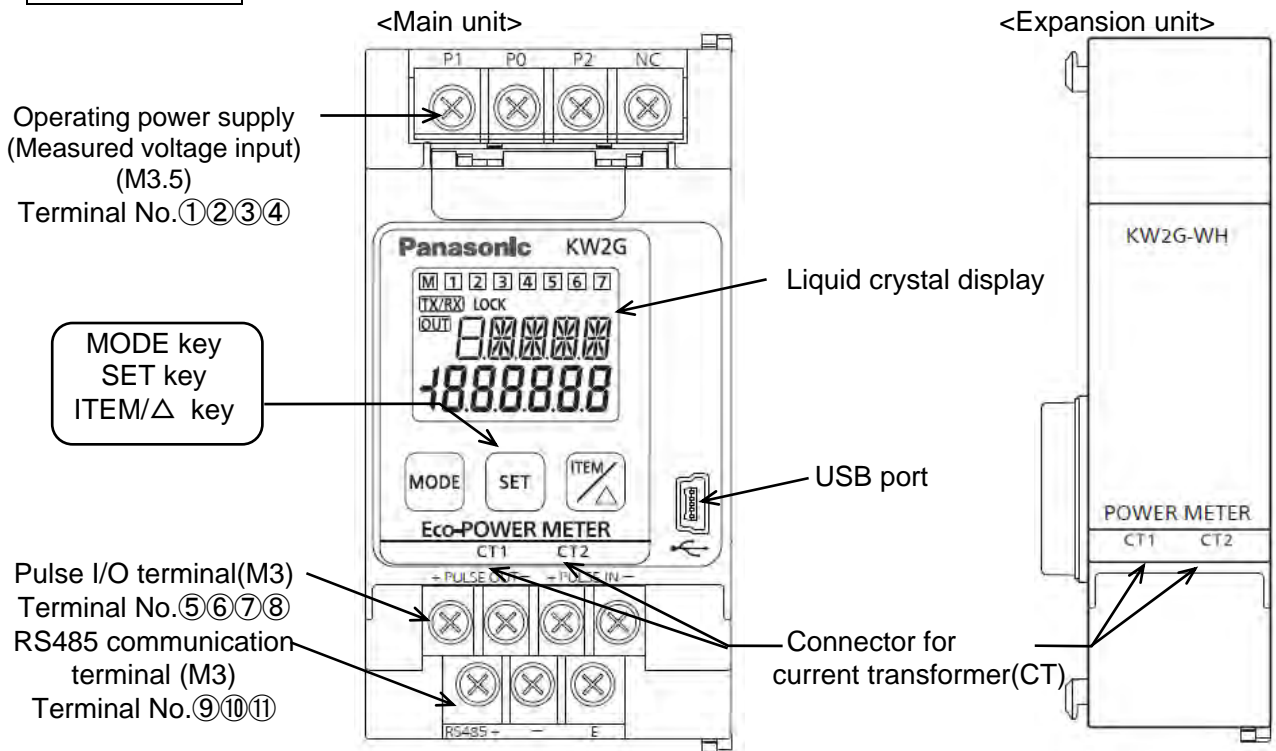

Side view

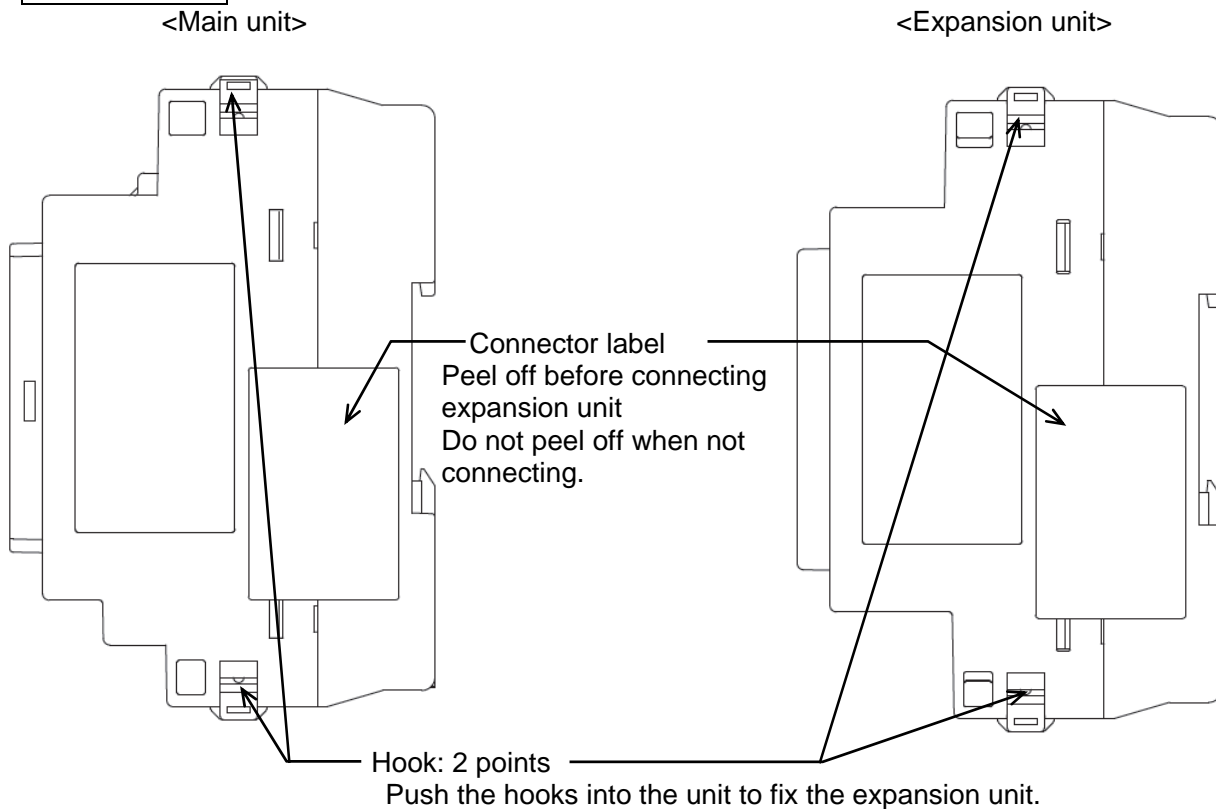

<Display>

- ① LOCK indicator
Key operation is invalid while lighting.
- ② TX/RX indicator
Lighting when communication
- ③ OUT indicator
Lighting when pulse output
- ④ Unit number indicator
M: Main unit
1 to 7: Expansion unit
- ⑤ Setting mode indicator
- ⑥ Each measurement value

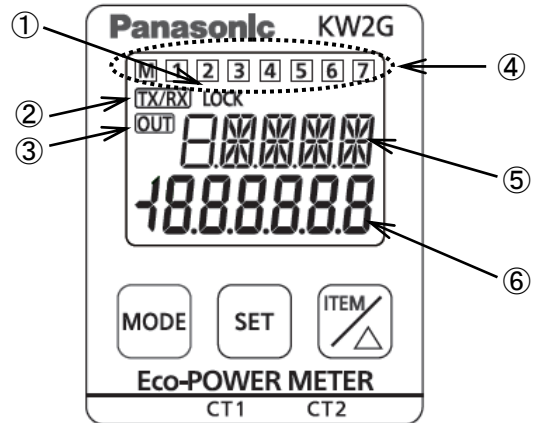

2.2 Key's Functions

<MODE>	• Shift unit number to display
<MODE> (continuous press 3-sec)	• Use to shift setting mode
<SET>	• Use to set each value entered • Reset stand-by alarm while output the alarm (only available while output the stand-by alarm)
<SET> (continuous press 3-sec)	• All keys locked • Release lock mode while in lock mode
<ITEM/Δ>	• To select measured value display (While monitoring) • To select setting value (While setting mode)
<SET> and <ITEM/Δ>	• To select measured value display (While monitoring) • To select setting value (While setting mode)
<ITEM/Δ> (continuous press 3-sec)	• Shift measured items to display (Instantaneous electric power, current, voltage)
<SET> and <MODE> (continuous press 3-sec)	• To reset the measured value

Chapter 3 Installation

3.1 Measured-circuit

- It is not impossible to use to measure several loads by different strain power supply.
- Each unit can measure 2-circuit of single-phase two-wire system, and 1-circuit of single-phase three-wire system or three-phase three-wire system.
- It is not impossible to measure by only the expansion unit. Connect expansion units to main unit.
Up to 7 expansion units are connected to 1 main unit.
- Connecting a main unit and expansion units, up to 16-circuit of single-phase two-wire system, up to 8-circuit of single-phase three-wire system or three-phase three-wire system can be measured.

3.2 Connection between the main unit and the expansion unit

- Turn off the power of main unit when connecting expansion units.
- When expanding the units, peel off connector label on the side of each unit and connect male connector to female connector.
Female connector is on the other side of male connector.
- After connecting, push the hooks into the unit to fix the expansion unit.
- Up to 7 expansion units can be connected per one main unit.

Note) Communication will be stopped or the measurement data will be lost when the units are removed or connected while turn on power.

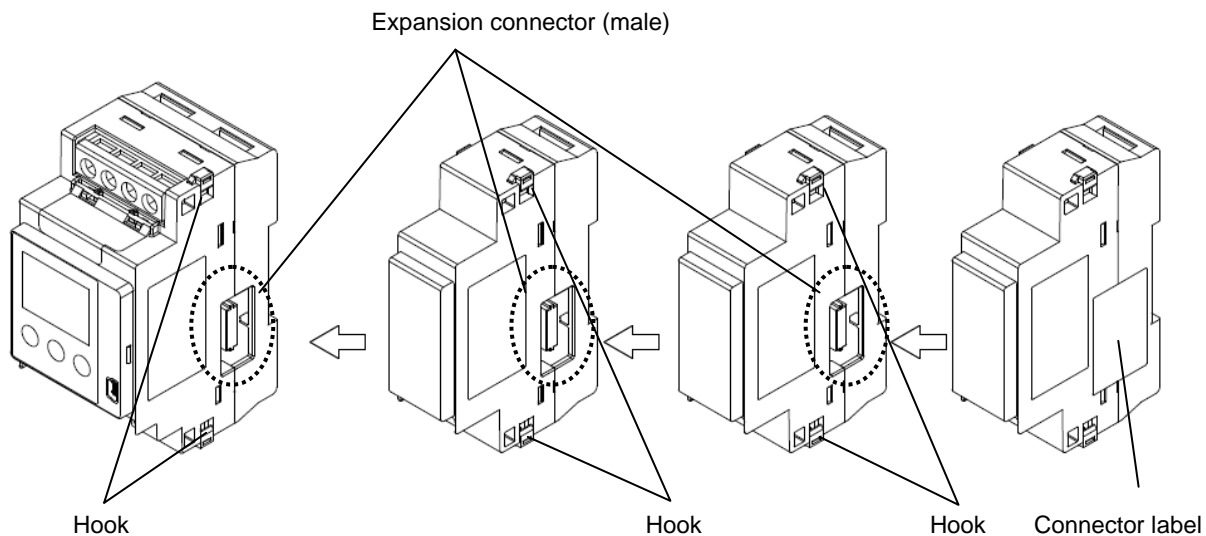

3.3 DIN rail mounting

Connect all expansion units to the main unit before mounting DIN rail, then mount all connected units to DIN rail.

Mount

- 1) Hang the unit on DIN rail.
- 2) Push it till making click sound and mount.

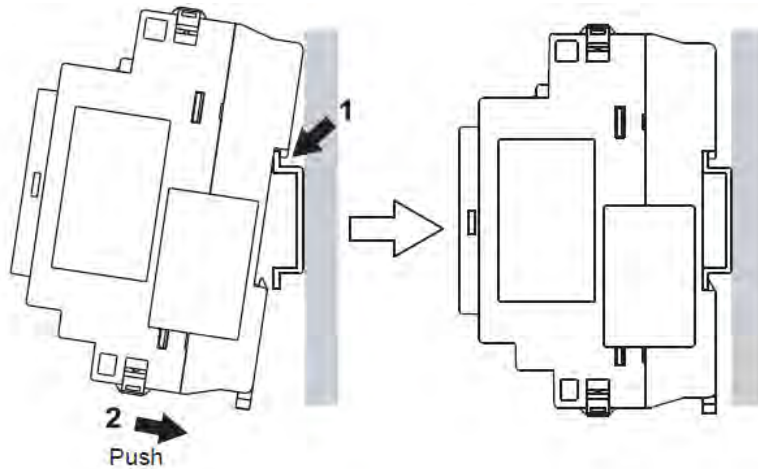

Note) Check the position of DIN hook (Fig.1) before mounting.

When several expansion units are connected and mounted to DIN rail, moving the hooks lower (Fig.2) makes mounting easy. After mounting, return to the position of Fig.1.

<Back of main unit> <Back of expansion unit>

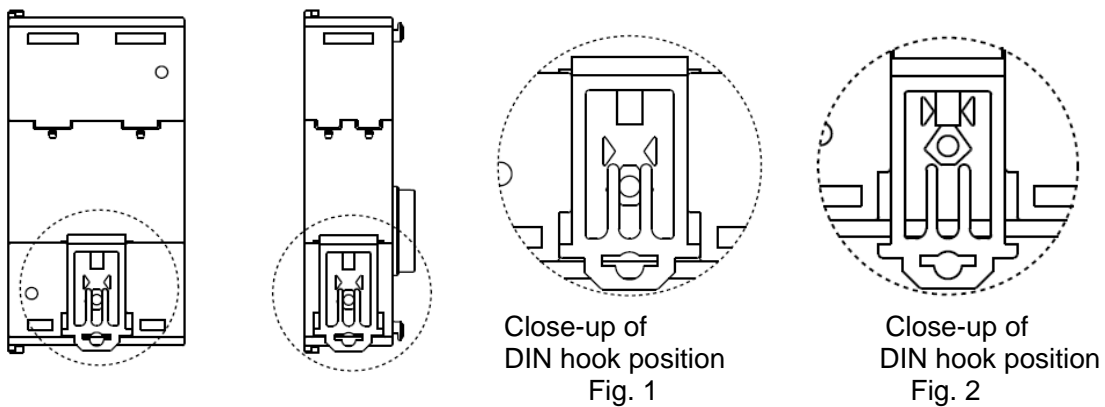

Remove

- 1) Insert minus driver etc. to DIN hook and displace down below.
- 2) Lift it in the direction of the arrow and remove it.

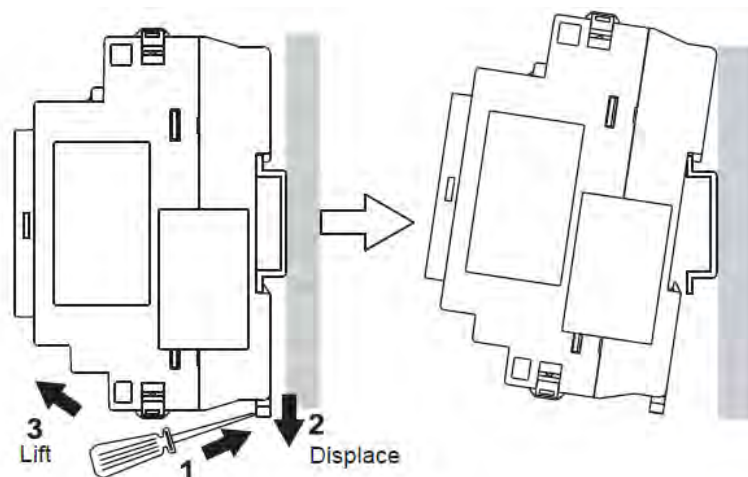

3.4 Terminal arrangement

Be sure to wire correctly according to the terminal arrangement and wiring diagrams. After completing wiring, be sure to attach the terminal cover for safety reasons.

No.	Function		Screw
Top	①	P1	Measured voltage input P1-P0 common to operating power supply
	②	P0	
	③	P2	
	④	NC	
Mid	⑤	+	Pulse output
	⑥	-	
	⑦	+	Pulse input
	⑧	-	
Bottom	⑨	+	RS485
	⑩	-	
	⑪	E	

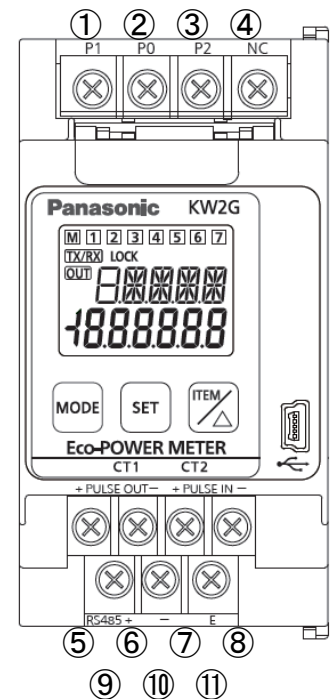

⚠ The input voltage to each terminal is as follows.

Terminal	Phase and wire	Terminal	Input voltage
Measured voltage input	Single-phase, two-wire	①-② (P1-P0)	100-240VAC (100-240V~) (Line voltage)
	Single-phase, three-wire	①-②-③ (P1-P0-P2)	100-120VAC (100-120V~ :3W) (Phase voltage)
	Three-phase, three-wire	①-②-③ (P1-P0-P2)	100-240VAC (100-240V 3~) (Line voltage)

Caution for Wiring

- Terminal fastening torque should be 0.5 to 0.6N·m for M3 screw and should be 0.8 to 1.0N·m for M3.5 screw. In case of using a crimping terminal, use it with insulating sleeve applicable to M3 screw or M3.5 screw.
- To protect the device, it is necessary to install power switch and circuit breaker in the power supply circuit. And this has no built-in power switch, circuit breaker or fuse for measured voltage input parts. Therefore it is necessary to install them in the circuit near this unit.
- We recommend a wire with the cross section of 0.75 to 1.25mm² for power supply line and measured voltage input line.
- Use with 10m or less of the input line and 100m or less of the output line.
- Use flame-resistant cable for each wiring.

<M3.5 screw>

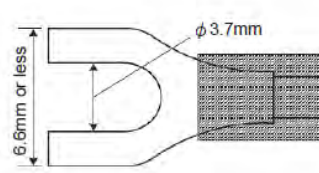
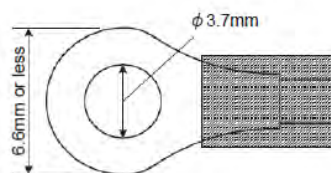

<M3 screw>

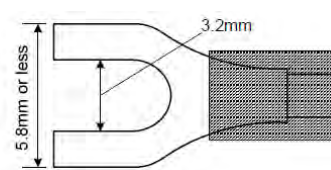
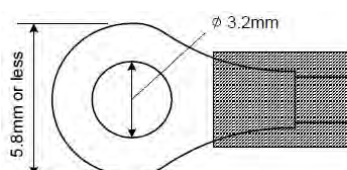

3.5 Wiring Diagram

3.5.1 In case of using only main unit

Please connect a breaker (3 to 15A) to the power supply (voltage input) part for safety reasons and to protect the device.

Single-phase two-wire system

◆When measuring a load with rated input voltage

One CT is needed to measure one load.

The below shows that it measures 2-circuit using 2 CTs connected to connectors of unit.

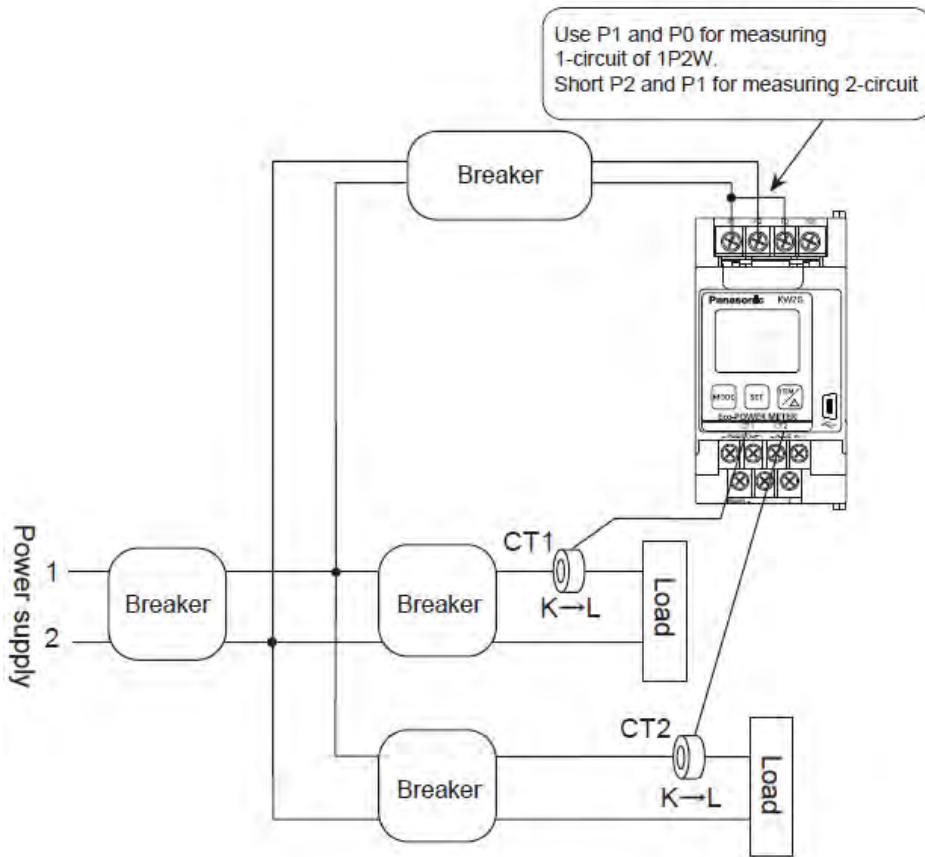

Note)

- (1) When wiring CT, wire correctly according to this, K for power supply side and L for load side.
- (2) 2 CTs should be same.

◆When measuring a load with exceed input voltage.

Voltage transformer (VT) is needed when you measure a load with over rated input voltage.

Use VT, its secondary side rating is 110V.

Grounding the secondary side of VT and CT is not necessary with low-voltage circuit.

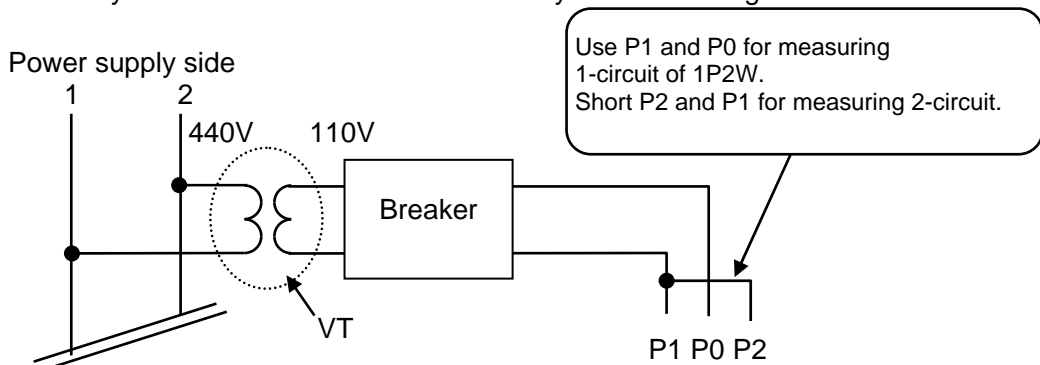

Single-phase three-wire system/Three-phase three-wire system

- ◆ When measuring a load with rated input voltage
Two CTs are needed to measure one load.

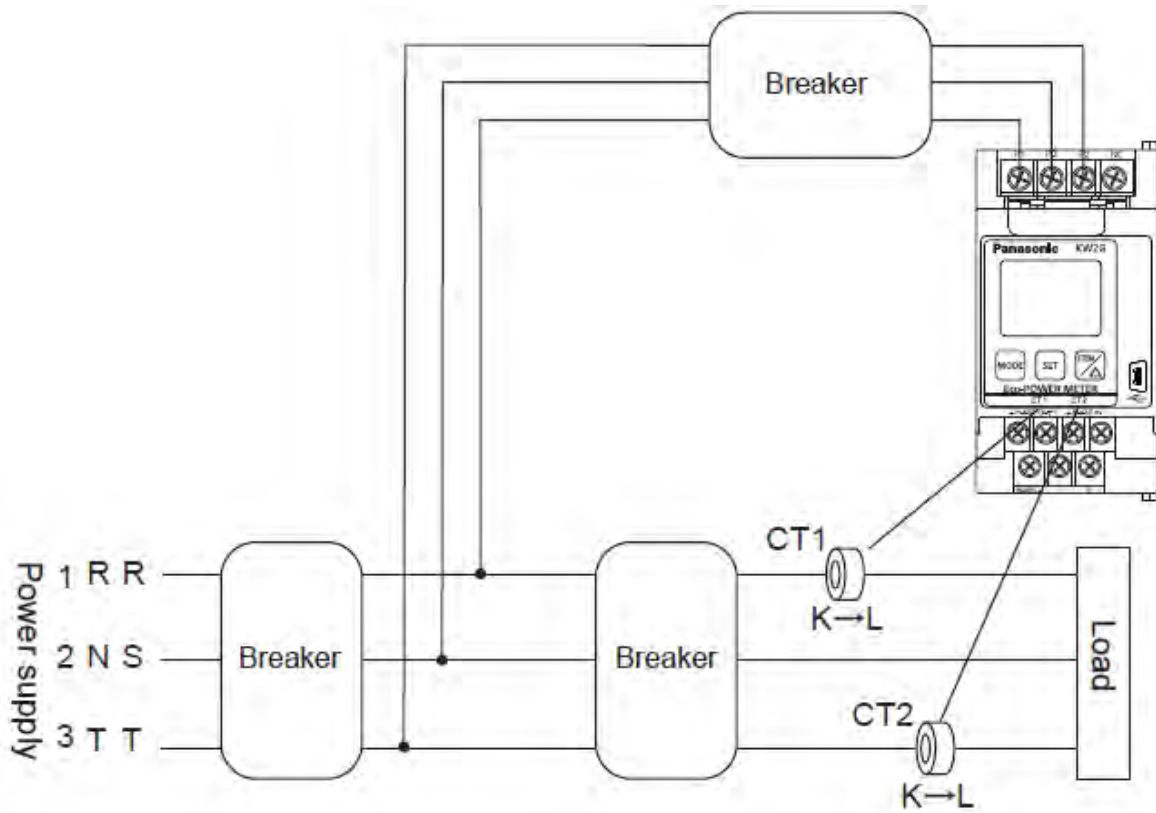

Note)

- (1) When wiring CT, wire correctly according to this, K for power supply side and L for load side.
- (2) 2 CTs should be same.

- ◆ When measuring a load with exceed input voltage.

Voltage transformer (VT) is needed when you measure a load with over rated input voltage.
Use VT, its secondary side rating is 110V.
Grounding the secondary side of VT and CT is not necessary with low-voltage circuit.

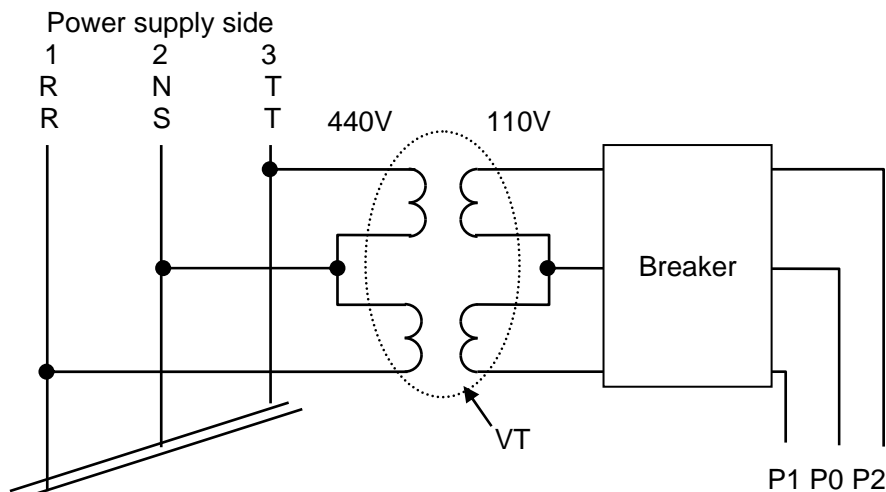

3.5.2 In case of using main unit and connected expansion units

Please connect a breaker (3 to 15A) to the power supply (voltage input) part for safety reasons and to protect the device.

Single-phase two-wire system

◆When measuring a load with rated input voltage

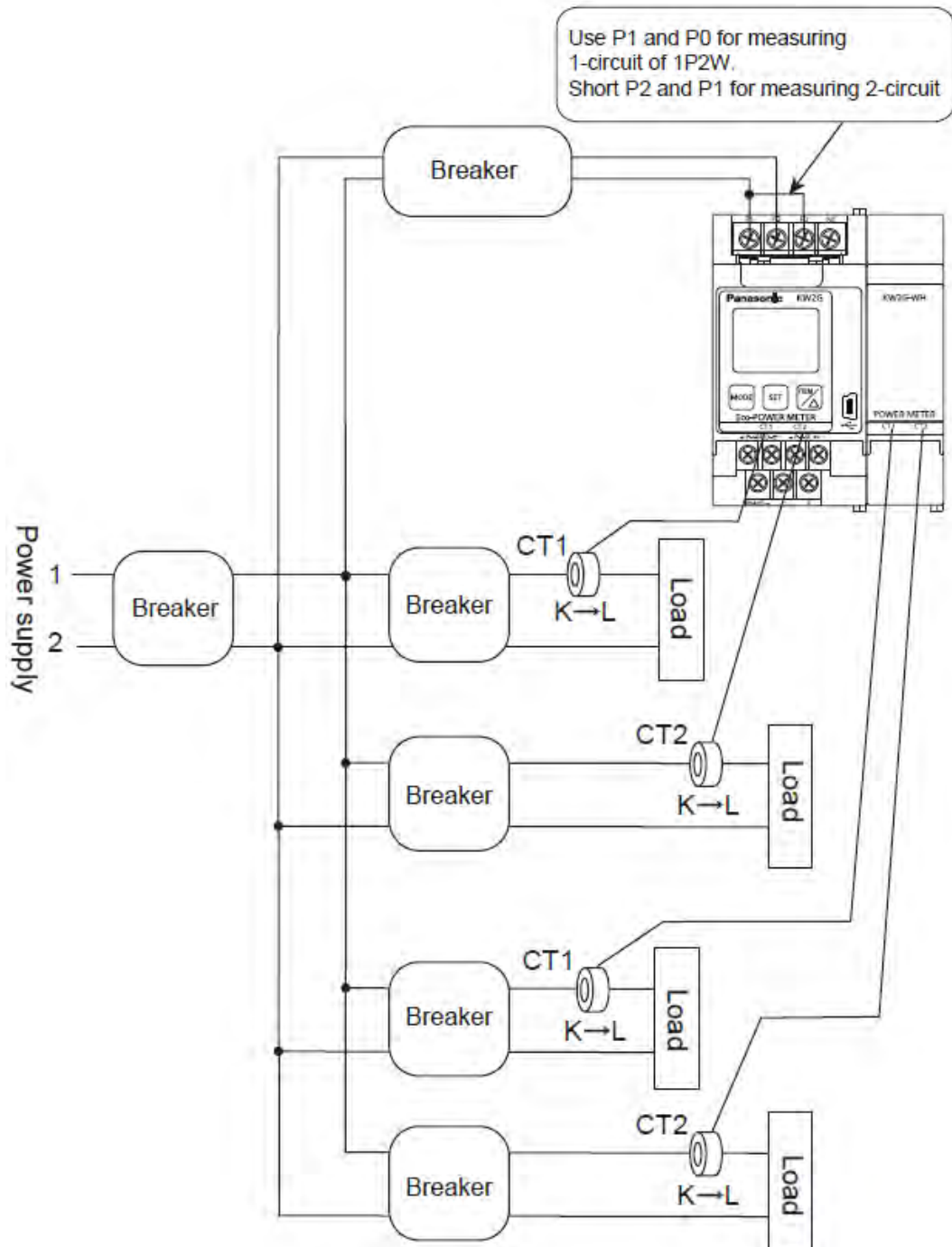

Note)

- (1) When wiring CT, wire correctly according to this, K for power supply side and L for load side.
- (2) Using all CTs for one unit should be same.

◆When measuring a load with exceed input voltage.

Voltage transformer (VT) is needed when you measure a load with over rated input voltage.

Use VT, its secondary side rating is 110V.

(Refer to the previous 3.6.1 in detail.)

Single-phase three-wire system/Three-phase three-wire system

◆When measuring a load with rated input voltage

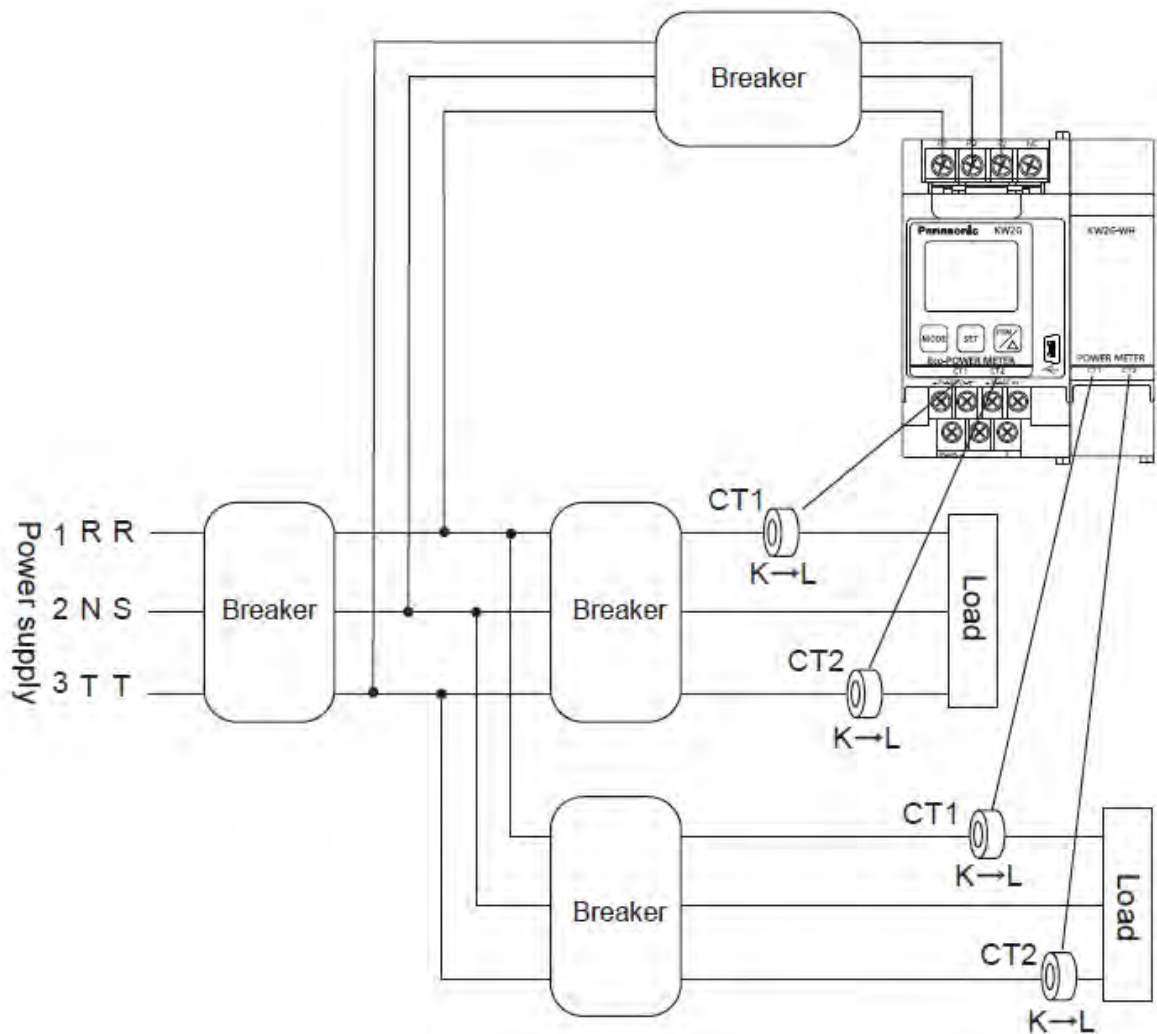

Note)

- (1) When wiring CT, wire correctly according to this, K for power supply side and L for load side.
- (2) Using all CTs for one unit should be same.

◆When measuring a load with exceed input voltage.

Voltage transformer (VT) is needed when you measure a load with over rated input voltage.
Use VT, its secondary side rating is 110V.
(Refer to the previous 3.6.1 in detail.)

3.6 How to attach the Current Transformer (CT)

- One CT is needed for 1 unit when measuring 1P2W (2 CTs for 2-circuit). Two CTs are needed when measuring 1P3W/3P3W. Using all CTs for one unit should be the same.
- Check beforehand that the thickness of the electric wire is smaller than the through-hole of the CT.
- When connecting CT, connect the secondary side to the terminal of the main unit first, and after that wire the primary side to a load electric wire. Incorrect order might cause an electric shock or break CT.
- The CT has polarity. Wire correctly according to the K and L marks. **Wrong direction can't measure correctly.**
- When closing CT, check that there is no foreign materials on the divided face. And make sure it is closed securely once the wire is in place; **if not the measurement value will be not accurate.**
- When CT's cable is extended, it is possible to extend up to about 10m with the cable of AWG#22 or more cross section under the environment without noise at all. Please use the thick cable as much as possible.

◆ To connect CT with secondary side current 5A

How to connect for measuring by combination with CT (secondary side current 5A)

- (1) Select 5A at CT type setting mode (CT-T).
- (2) Set the primary current of measured CT (secondary side current 5A) at primary side current of CT setting mode (CT-1).
< ex > If the measured CT is 400A/5A, set to "400".
- (3) Clamp the dedicated CT for 5A (AKW4801C), which is connected to the main unit first, to secondary side of the CT (secondary side current 5A). CT direction (K→L) should be set for the commercial CT direction.

*** Set the CT (secondary side current 5A) and the AKW4801C approximately 1m apart. If the two CTs are set too close each other, it may not measure accurately due to magnetic field interference.**

(Connection example)

With Ammeter etc.

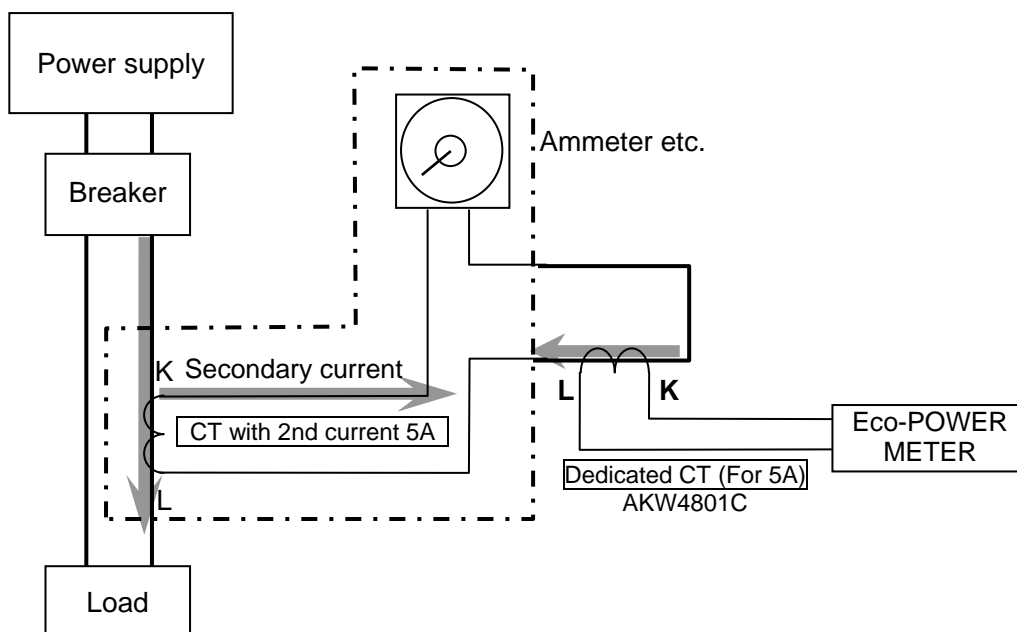

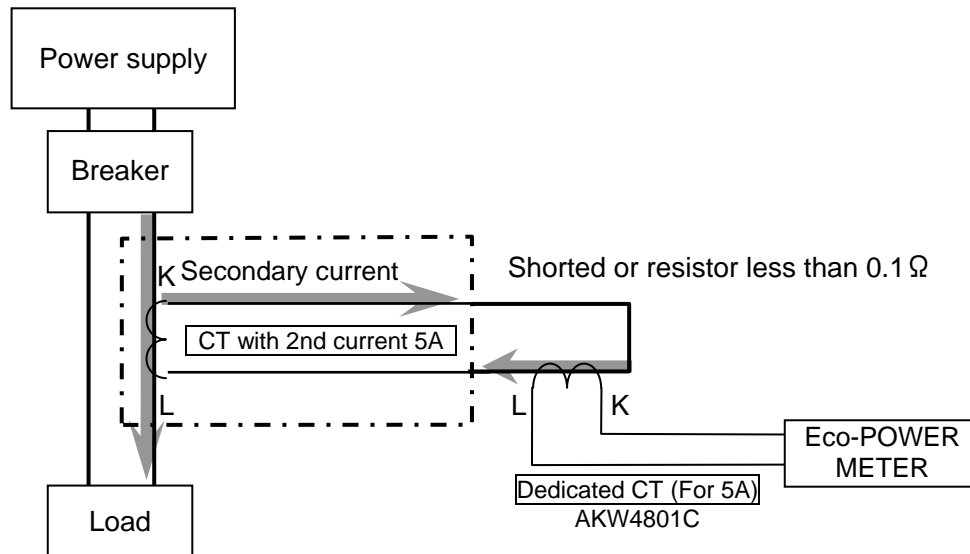
Without Ammeter**3.7 For input connection**

• Contact input

Use highly reliable metal plated contacts. Since the contact's bounce time leads directly to error in the count value, use contacts with as short a bounce time as possible. In general, select 30Hz for max. counting speed.

• Non-contact input (Transistor input)

Connect with an open collector. Use the transistor with the following specifications. $V_{CE0}=20V$ min. $I_C=20mA$ min. $I_{CBO}=6 \mu A$ max

Use transistors with a residual voltage of less than 2V when the transistor is ON.

* Short-circuit impedance should be less than $1k \Omega$.

(When the impedance is 0Ω , drain current is approx. 7mA.)

Open-circuit impedance should be more than $100k \Omega$.

• Input wiring

Please wire up to 10m by using a shielded wire or a metallic electric wire tube individually.

(Note)

Operating power supply input part and measured voltage input are not insulated to pulse input parts. So the input equipment must have the power supply transformer in which the secondary side is not grounded with the primary and secondary sides insulated, in order to prevent interference of the power supply circuit when connecting the external input circuit. Be sure not to use an auto-transformer.

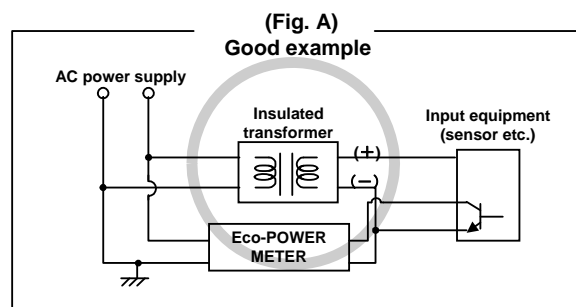
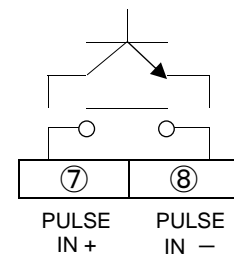

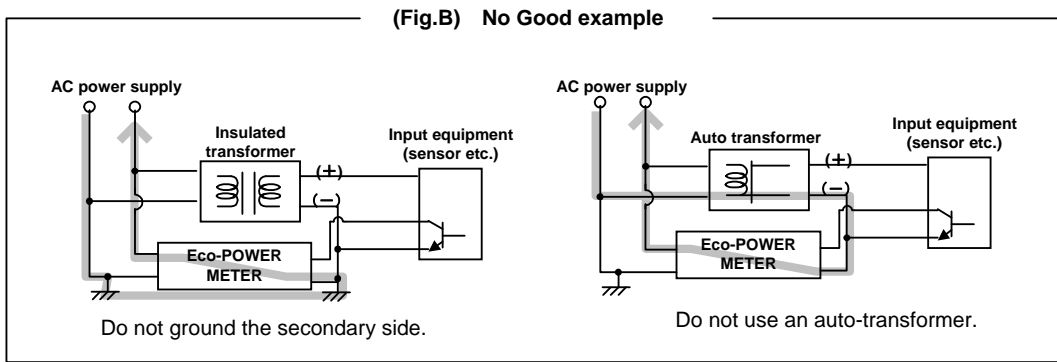

3.8 For Output connection

- Since the transistor output is insulated from the internal circuit by a photo-coupler, it can be used both as a NPN output and PNP (equal value) output.

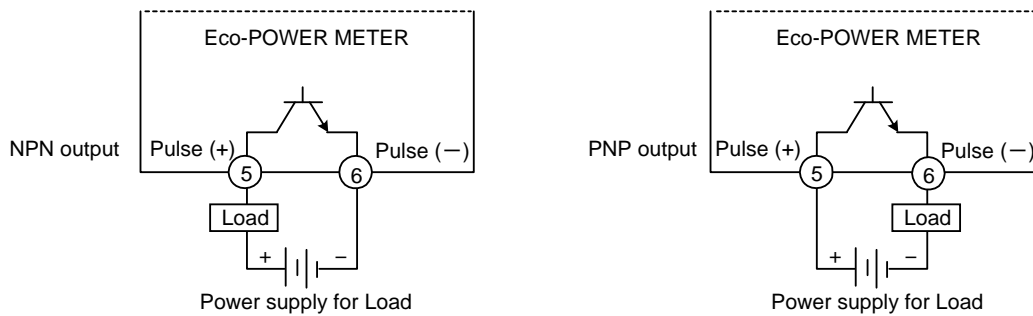

- Wire up to 100m for output connection.

3.9 RS485 communication

- When using shielded cable for the RS485 transmission line, ground one end. Use a class D dedicated earth for grounding. Do not share a ground with other earth lines. (Fig.1)
- Be sure to connect with daisy chain the RS485 transmission line between each unit. Do not use a splitter. (Fig.2)
- With a terminal station, RS485 (E) and RS485 (-) should be shorted.

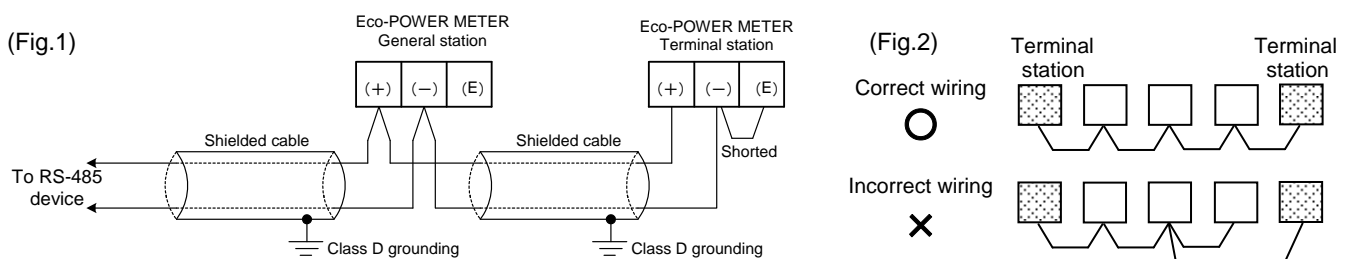

Recommended Cable

Use the transmission cables shown below for Eco-POWER METER RS485 communication system.

Cable	Conductor		Insulator		Cable diameter	Applicable cable
	Size	Resistance (at 20°C)	Material	Thickness		
Twisted-pair with shield	1.25 mm ² (AWG16) or more	Max.16.8Ω/km	Polyethylene	Max. 0.5 mm	Approx. 8.5 mm	HITACHI KPEV-S 1.25 mm ² × 1P Belden Inc. 9860
	0.5 mm ² (AWG20) or more	Max.33.4Ω/km	Polyethylene	Max. 0.5 mm	Approx. 7.8 mm	HITACHI KPEV-S 0.5 mm ² × 1P Belden Inc. 9207
VCTF	0.75 mm ² (AWG18) or more	Max.25.1Ω/km	PVC	Max. 0.6 mm	Approx. 6.6 mm	VCTF 0.75 mm ² × 2C (JIS)

Cable	Section
Twisted-pair with shield	
VCTF	

Notes

- 1) Use shielded type twist cables.
- 2) Use only one type of the transmission cables. Do not mix different types of the cables.
- 3) Use twist pair cables under a bad noise environment.

3.10 Low Voltage Directive

When using in the application conforming to EN61010-1/IEC61010-1, make sure to satisfy the following conditions.

- (1) Pulse output part and communication part secure only basic insulation. In order to secure reinforced (double) insulation demanded by EN 61010-1/ IEC61010-1, secure basic insulation or more with load side for output part and secure basic insulation or more with communication system side for communication part.
- (2) Provide the voltage input part with an EN60947-1 or EN60947-3 compliant circuit breaker. The breaker that connects to the voltage input part must arrange at the position easily reached, and display shows it is the breaker of the equipment.
- (3) Use a wire with basic insulation or more for a wire cramped (or connected) CT.

【Environmental conditions】

- Overvoltage category II, Pollution degree 2
- Indoor use
- An ambient temperature of -10 to 50°C
- An ambient non-condensing humidity of 35 to 85%RH (at 20°C)
- Altitude of 2000m or less

【Mount the product in a place with】

- A minimum of dust, and an absence of corrosive gases
- No flammable, explosive gasses
- Few mechanical vibrations or shocks
- No exposure to direct sunlight
- No large capacity electromagnetic switches or cables through which large current is flowing

Chapter 4 Settings

4.1 Operation procedure

When power on, [M] and connected expansion unit number turn on the display of main unit. After that, it displays the monitor display (measuring value).

【Basic setting to measure】

When wiring Eco-POWER METER and CT and setting mode 1 after power on, Eco-POWER Meter can measure the electric power. In order to use the other functions, set mode2, 3 and 4 according to your use.

Mode 1: Mode for setting about power measurement

Mode 2: Mode for setting about pulse measurement

Mode 3: Mode for setting about serial communication (RS485)

Mode 4: Mode for setting about optional function

In addition, when connecting main unit and expansion units, there are some items that are necessary to set each unit.

【Unit change】

Before setting, press <MODE> to shift display of main unit (M) and expansion units (1 to 7) to set.

Settings about functions of pulse output, alarm output and communication on main unit can be set even if it changes to an expansion unit.

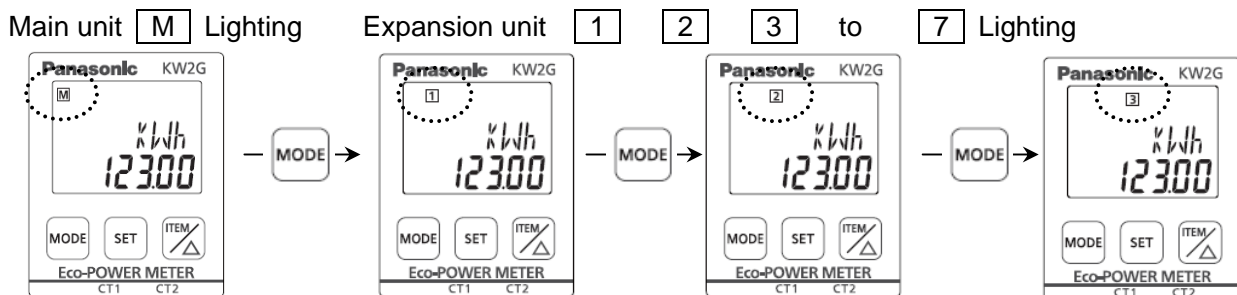

Mode 1...Mode for setting each parameter for power measurement

The mode with (※) mark can be set to each unit.

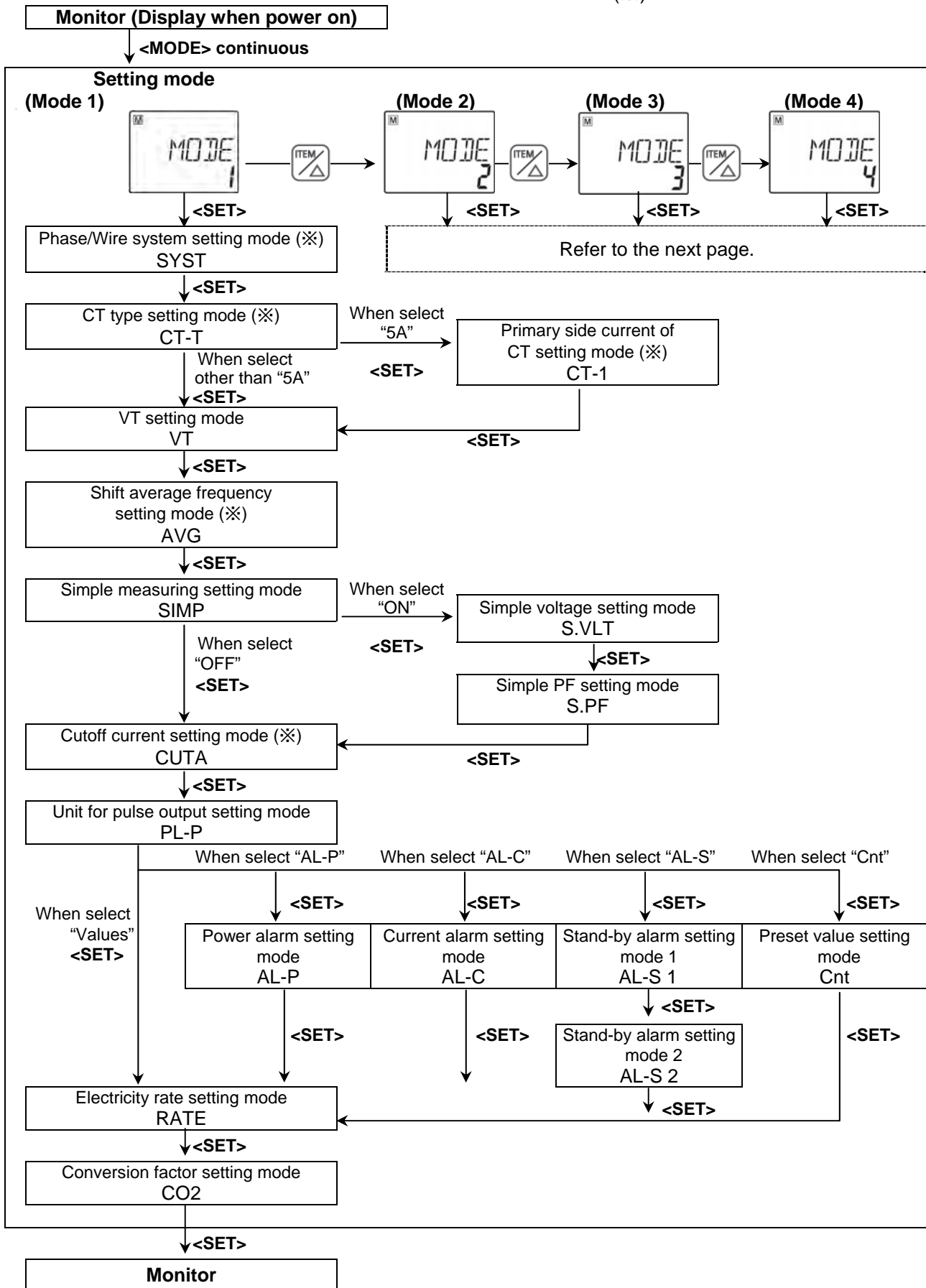

Press <MODE> to return Monitor.

- Mode 2...Mode for setting of each parameter for pulse measurement
- Mode 3...Mode for setting of each parameter for serial communication
- Mode 4...Mode for setting of each parameter for optional function

The mode with (※) mark can be set to each unit.

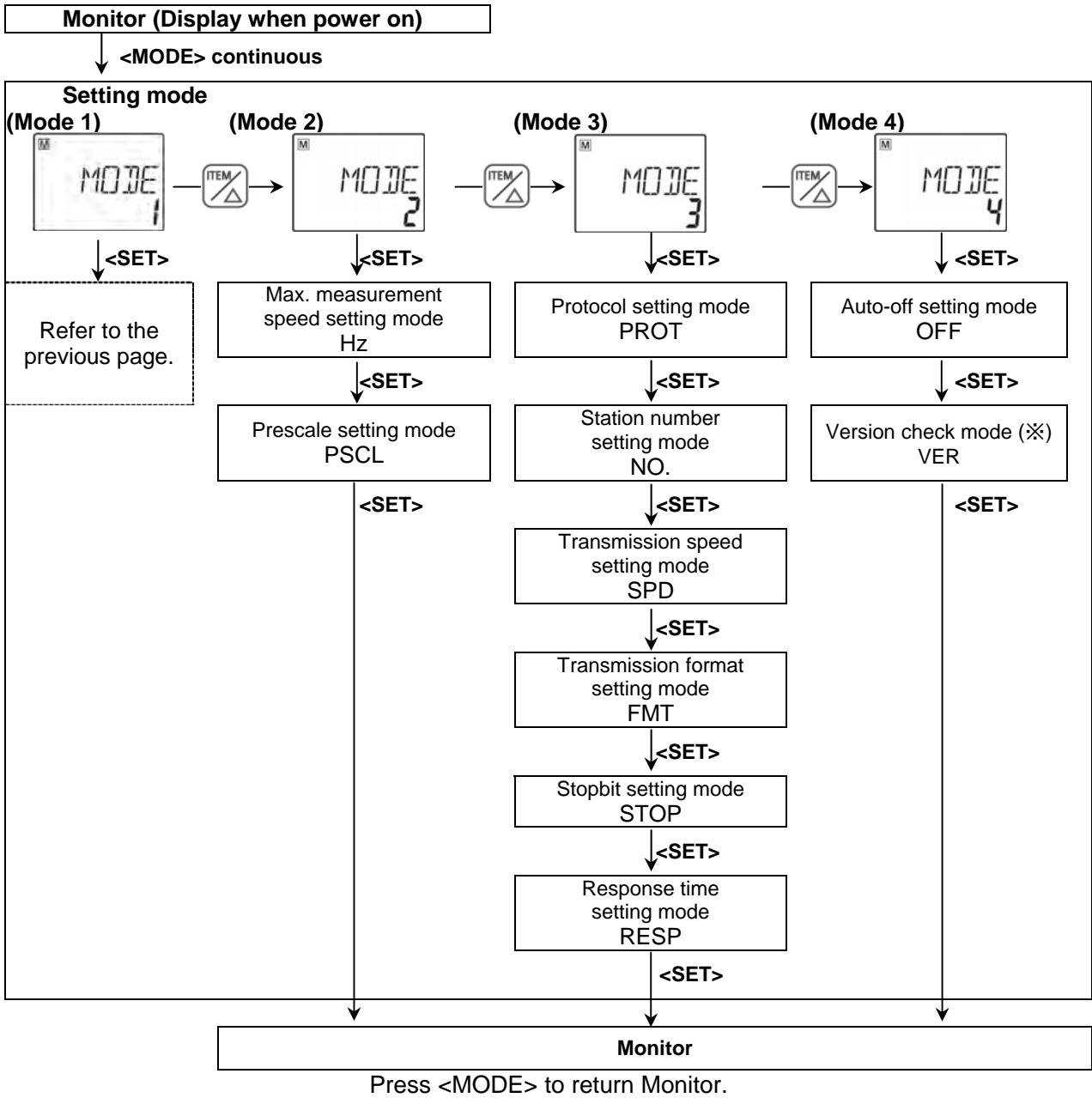

◆ Initial value list

Mode 1		Mode 2	
Item	Initial value	Item	Initial value
Phase/Wire system (※)	1P2W	Max. measurement speed	50000
CT type (※)	50		
Primary side current of CT (※)	5	Prescale	1.000
VT	1.00		
Shift average frequency (※)	8		
Simple measuring	OFF		
Simple voltage	110.0		
Simple PF	1.00		
Cutoff current (※)	0.1		
Unit for pulse output	0.001		
Power alarm	9999.99		
Current alarm	100.0		
Stand-by alarm1	100.00		
Stand-by alarm 2	0		
Preset value	0		
Electricity rate	10.00		
Conversion factor	0.410		

Mode 3		Mode 4	
Item	Initial value	Item	Initial value
Protocol	MEWTOCOL	Auto-off	0
Station number	1		
Transmission speed	19200		
Transmission format	8bit-o		
Stop bit	1		
Response time	1		

4.2 Setting Mode Explanation

■ The value with under line “ ” is initial setting among each setting value. ☆ Set before measurement.

4.2.1 MODE 1

(Mode for setting each parameter for power measurement.)

The mode with (※) mark can be set to each unit.

Phase/Wire system setting mode (※) SYST

Mode defines phase and wire system to measure.

- Select from Single-phase 2-wire / Single-phase 3-wire / Three-phase 3-wire.
- Select the system of the measured load.

*When the system is not matched with the measure system, it doesn't measure correctly.

CT type setting mode (※) CT-T

Mode defines input current type of the dedicated CT.

- Select from the type of 5A/50A/100A/250A/400A.
- When the secondary current of CT is 5A, select “5A”.

Primary side current of CT setting mode (※)CT-1

*Only when “5A” is selected on CT type setting mode.

Mode defines primary side current when measuring by combination with another CT, its secondary current of 5A.

It is possible to use as the second step for combination with another CT by selecting “5A” in the CT type setting mode. In this case, it is necessary to set the primary side current.

- Primary side current of the measured CT can be set the range of 1 to 4000 (Initial 5).
- When connecting 5A CT directly and measure with 5A range, set to “5”.
- ex) If primary current of measured CT is 400A (secondary side is 5A), set to “400”.

VT setting mode VT

Mode defines voltage input method to the main unit, input voltage directly or uses a voltage transformer (VT) (over 440V system).

- It can be set the range of 1.00 to 99.99.
- “1.00” should be set when voltage input directly without connecting VT.
- “1.01 to 99.99” should be set when VT is used to input voltage.

Shift average frequency setting mode (※) AVG

Mode defines shift average frequency for instantaneous value.

When unevenness of the measurement value is large, you can suppress the unevenness by setting bigger average frequency.

In order to measure in detail including unevenness, select “0”.

- Select from 0 / 2 / 4 / 8 / 16.

Setting of the shift average frequency reflects to electric power, current and voltage.

Ex.: When selecting “4”

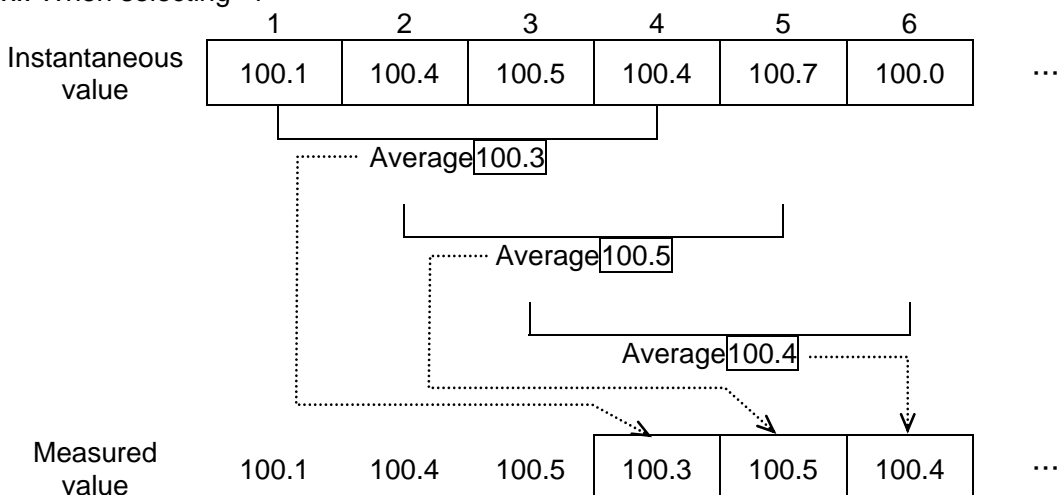

Simple measuring setting mode **SIMP**

It can measure electric power using only measured current with fixing voltage and power factor.

You can use this function when it is impossible to input measured voltage due to the load situation or wiring conditions. Simple measuring is a function to grasp rough electric power of the measurement circuit without measuring voltage.

• Select from OFF / ON.

“ON”: Use this function (set and fixes voltage and power factor)

* During simple measuring, it doesn't guarantee the accuracy because voltage and power factor are fixed.

* Frequency of the operating power supply is displayed.

Wiring example:

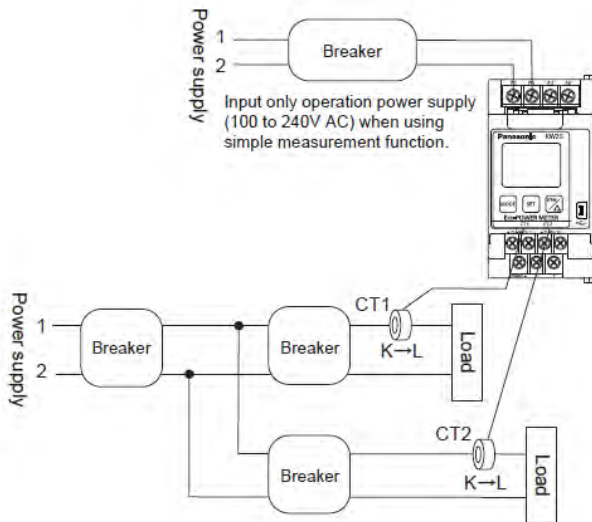
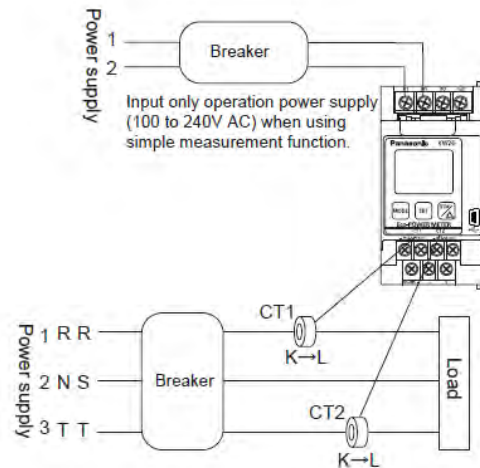
Single-phase two-wire**Single-phase three-wire/Three-phase three-wire****Simple voltage setting mode** **S.VLT**

* Only when “ON” is selected on simple measuring setting mode.

Mode defines voltage value to use for simple measuring.

• It can be set the range of 0.0 to 9999.9V (initial: 110.0V).

Simple PF setting mode **S.PF**

* Only when “ON” is selected on simple measuring setting mode.

Mode defines power factor to use for simple measuring.

• It can be set the range of 0.00 to 1.00 (initial: 1.00).

Cutoff current setting mode (※) **CUTA**

Mode defines load current that does not measure (Cutoff current).

Use to avoid miss-measurement by wiring or induction noise at no-load.

0.00kW is displayed for instantaneous electric power, 0.0A is displayed for current. Integrated electric power is not added.

• It can be set the range of 0.1 to 50.0%.

ex) When set to 10.0, current (=power) under 10.0%F.S is not added.

Unit for pulse output setting mode **PL-P**

Mode defines unit used for pulse output. It defines the unit of integrated electric power for 1-pulse output.

• Select from 0.001/0.01/0.1/1/10/100kWh /AL-P/AL-C/AL-S/Cnt.

When one of the “0.001/0.01/0.1/1/10/100” [kWh] is set, one pulse is output at reaching the setting value.

When “AL-P” is set, alarm is output at the time when instantaneous electric power is over the setting value.

When “AL-C” is set, alarm is output at the time when current is over the setting value.

When “AL-S” is set, alarm is output at the time when current is under the setting value and it passes the setting time.

When “Cnt” is set, it output at the time when count value reaches preset value set by preset value setting mode.

Power alarm setting mode **AL-P**

** Only when “AL-P” is selected on unit for pulse output setting mode.*

Mode defines instantaneous electric power used for alarm output.

• It is set the range of 0.00 to 9999.99kW.

Current alarm setting mode **AL-C**

** Only when “AL-C” is selected on unit for pulse output setting mode.*

Mode defines the ratio of current used for alarm output. (Ratio for the rated current)

• It is set the range of 0.1 to 100.0%.

Stand-by alarm setting mode 1 **AL-S**

** Only when “AL-S” is selected on unit for pulse output setting mode.*

Mode defines the ratio of current used for threshold value to judge stand-by power.

(Ratio for the rated current)

• It is set the range of 0.1 to 100.0%.

Stand-by alarm setting mode 2 **AL-S**

** Only when “AL-S” is selected on unit for pulse output setting mode.*

Mode defines the time used for threshold value to judge stand-by power.

• It is set the range of 0 to 9999min.

When “0” is set, alarm is always output at the time when judging the stand-by power.

When “1 to 9999” is set, alarm is output at the time when passing the setting time with the stand-by power.

The alarm can be reset by pressing <SET> with the instantaneous electric power display. After reset the alarm, start to monitor the stand-by power again.

Preset value setting mode **Cnt**

** Only when “Cnt” is selected on unit for pulse output setting mode.*

Mode defines count value used for output.

• It is set the range of 0(0.000) to 999999(999.999).

** The range differs according to the pre-scale set by pre-scale setting mode.*

Electricity charge setting mode **RATE**

Mode defines electricity charge ratio used as a standard per 1kWh.

• It can be set the range of 0.00 to 99.99 /1kWh. (Initial 10.00)

Conversion factor setting mode **CO2**

Mode defines conversion factor of carbon dioxide used as a standard per 1kWh.

• It can be set the range of 0.000 to 9.999/1kWh. (Initial 0.410)

Mode1 Setting flow chart

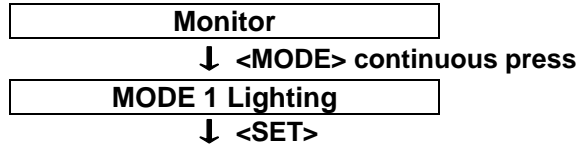

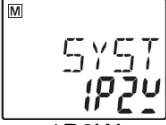

Phase/Wire system setting mode (※)
 Press <ITEM/Δ> to change Single-phase 2-wire ⇒ Single-phase 3-wire ⇒ Three-phase 3-wire.

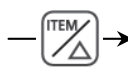
 1P2W





 1P3W





 3P3W

↓ <SET>

CT type setting mode (※)
 Press <ITEM/Δ> to change 50 ⇒ 100 ⇒ 250 ⇒ 400 ⇒ 600 ⇒ 5.



 50





 100





 250

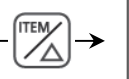



 400

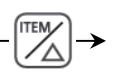

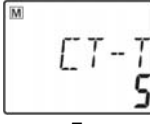

 600



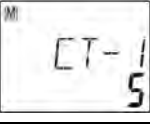

 5

↓ <SET>

Primary side current of CT setting mode (※) *It is only when "5A" is selected on CT type setting mode.
 Set primary side current of CT using <ITEM/Δ>, <SET>+<ITEM/Δ>.
 If measured CT is 100A/5A, set to 100. If 5A is measured, set to 5.



 (1 to 4000, initial: 5)

	Increase
SET + 	Decrease

↓ <SET>

VT ratio setting mode
 Set VT ratio using <ITEM/Δ>, <SET>+<ITEM/Δ>.
 If the VT is 440/110, set to "4.00".



 (1.00 to 99.99)

	Increase
SET + 	Decrease

↓ <SET>

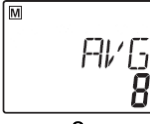
Shift average frequency setting mode (※)
 Press <ITEM/Δ> to change 8 ⇒ 16 ⇒ 0 ⇒ 2 ⇒ 4.



 8

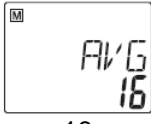



 16





 0

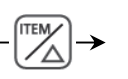

 2

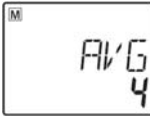

 4

↓ <SET>

Simple measuring setting mode
 Press <ITEM/Δ> to change OFF ⇔ ON.
 Select "ON" in order to use simple measuring function.

↓ <SET>

Simple voltage setting mode * It is only when "ON" is selected on Simple measuring setting mode.
 Set voltage value to use for simple measuring using <ITEM/Δ>, <SET>+<ITEM/Δ>.
 If it is 220V, set to "220.0".

↓ <SET>

Simple PF setting mode * It is only when "ON" is selected on Simple measuring setting mode.
 Set power factor to use for simple measuring using <ITEM/Δ>, <SET>+<ITEM/Δ>.
 If it is 0.9, set to "0.90".

↓ <SET>



Cutoff current setting mode (※)
 Set cutoff current ratio using <ITEM/Δ>, <SET>+<ITEM/Δ>.
 If you don't measure the current under 10.0%F.S, set to "10.0".

↓ <SET>

Unit for pulse output setting mode
 Press <ITEM/Δ>, <SET>+<ITEM/Δ> to change 0.001 ⇔ 0.01 ⇔ 0.1 ⇔ 1 ⇔ 10 ⇔ 100 ⇔
 AL-P(Power alarm) ⇔ AL-C(Current alarm) ⇔ AL-S(Stand-by alarm) ⇔ Cnt(Count output)

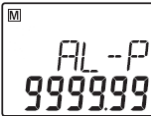

↓ <SET>

Power alarm setting mode *It is only when "AL-P" is selected on unit for pulse output setting mode.
Set power for alarm using <ITEM/Δ>,<SET>+<ITEM/Δ>.

	(0.00 to 9999.99)		Increase
			Decrease

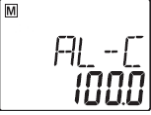

↓ <SET>

Current alarm setting mode *It is only when "AL-C" is selected on unit for pulse output setting mode.
Set current ratio (for the rated current) for alarm using <ITEM/Δ>,<SET>+<ITEM/Δ>.

	(0.1 to 100.0)		Increase
			Decrease



↓ <SET>

Stand-by alarm setting mode 1 *It is only when "AL-S" is selected on unit for pulse output setting mode.
Set a ratio (for the rated current) of current used for threshold value to judge stand-by power using <ITEM/Δ>,<SET>+<ITEM/Δ>.

	(0.1 to 100.0)		Increase
			Decrease

↓ <SET>

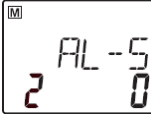

Stand-by alarm setting mode 2 *It is only when "AL-S" is selected on unit for pulse output setting mode.
Set a time used for threshold value to judge stand-by power using <ITEM/Δ>,<SET>+<ITEM/Δ>.

	(0 to 9999 min.)		Increase
			Decrease

"0": Alarm is always output at the time when judging the stand-by power.
"1 to 9999": Alarm is output at the time when passing the setting time with the stand-by power.
The alarm can be reset by pressing <SET> **with the instantaneous electric power display**.
After reset the alarm, start to monitor the stand-by power again.



↓ <SET>

Preset value setting mode *It is only when "Cnt" is selected on unit for pulse output setting mode.
Set preset value to output using <ITEM/Δ>,<SET>+<ITEM/Δ>.

	(0 to 999999)		Increase
			Decrease

↓ <SET>

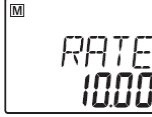

Electricity charge setting mode
Set the rate per kWh using <ITEM/Δ>,<SET>+<ITEM/Δ>.

	(0.00 to 99.99, initial: 10.00)		Increase
			Decrease

↓ <SET>

Conversion factor setting mode

Set the conversion factor per 1kWh using <ITEM/Δ>,<SET>+<ITEM/Δ>.

 (0.000 to 9.999, initial: <u>0.410</u>)	 Increase
	 Decrease

↓ <SET>

Monitor

4.2.2 Mode 2

(Mode for setting of each parameter for pulse measurement: Mode 2 is for the functions of main unit.)

Max. counting speed setting mode **Hz**

Mode defines max. counting speed.

- Select from 30Hz/50kHz

Pre-scale setting mode **PSCL**

Mode defines pre-scale value used for changing count value.

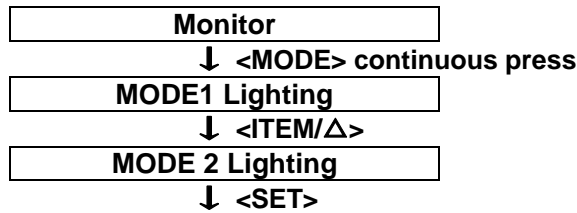

- It can be set the range of 0.001 to 100.000. (Initial 1.000)
- The position of decimal point set with this mode is applied to count value and preset value.
- ex) When "0.010" (Last 2-digit) is set, the decimal point of count value and preset value has 2 digit under decimal point.

Mode2 Setting flow chart



Max. counting speed setting mode

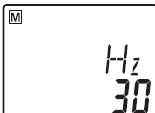

Press <ITEM/Δ> to change 50000(50kHz) ↔ 30(30Hz).

 50000(50kHz)		 30(30Hz)
--	---	---

↓ <SET>

Pre-scale setting mode

Set pre-scale value using <ITEM/Δ>,<SET>+<ITEM/Δ>.

 (0.001 to 100.000, initial: <u>1.000</u>)	 Increase
	 Decrease

↓ <SET>

Monitor

4.2.3 Mode 3

(Mode for setting of each parameter for serial communication: Mode 3 is for the functions of main unit.)

Protocol setting mode PROT

Mode defines communication protocol of main unit via serial communication (RS485).

• Select from MEWTOCOL / MODBUS(RTU).

Station number setting mode NO

Mode defines an individual station no. for each unit when two or more units communicate via serial communication (RS485).

• It can be set the range of 1 to 99.

Transmission speed (Baud rate) setting mode SPD

Mode defines serial communication (RS485) transmission speed. Define the transmission speed according to the master's (PLC etc.).

• Select from 2400 / 4800 / 9600 / 19200 / 38400 [bps].

Transmission format setting mode FMT

Mode defines serial communication (RS485) transmission format (Data length, Parity). Define the transmission format according to the master's (PLC etc.).

• Select from 8bit-o/7bit-n/7bit-E/7bit-o/8bit-n/8bit-E.

“n (none)” means parity is not available.

“E (Even)” means parity is even number.

“o (odd)” means parity is odd number.

* With MODBUS(RTU) protocol, it works only with 8bit.

Stop bit setting mode STOP

Mode defines serial communication (RS485) stop bit.

• Select from 1 / 2.

Response time setting mode RESP

Mode defines serial communication (RS485) response time of main unit.

When command is received, it sends response after setting response time passes.

• It can be set the range of 1 to 99 ms.

Mode3 Setting flow chart

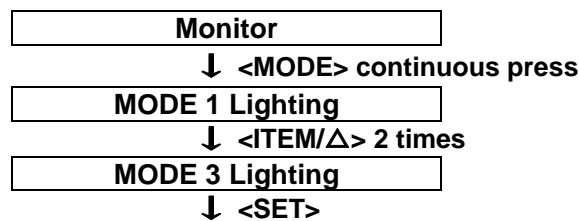

Protocol setting mode

Press <ITEM/Δ> to change MEWTOCOL ⇔ MODBUS(RTU).

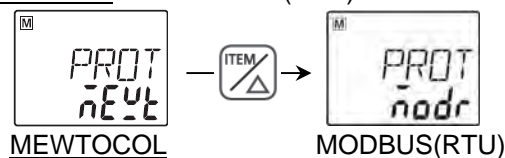

↓ <SET>

Station number setting mode

Set the station number using <ITEM/Δ>,<SET>+<ITEM/Δ>.

(1 to 99)

Increase
 Decrease

↓ <SET>

Transmission speed setting mode

Press <ITEM/Δ>,<SET>+<ITEM/Δ> to change 19200 ↔ 38400 ↔ 2400 ↔ 4800 ↔ 9600.

19200bps

→
 ←

38400bps

→
 ←

2400bps

→
 ←

4800bps

→
 ←

9600bps

↓ <SET>

Transmission format setting mode

Press <ITEM/Δ>,<SET>+<ITEM/Δ> to change 8bit-o ↔ 7bit-n ↔ 7bit-E ↔ 7it-o ↔ 8bit-n ↔ 8bit-E.

8bit-o

→
 ←

7bit-n

→
 ←

7bit-E

→
 ←

7bit-o

→
 ←

8bit-n

→
 ←

8bit-E

n: not available
E: even number
o: odd number

↓ <SET>

Stop bit setting mode

Press <ITEM/Δ> to change 1 ↔ 2.

1

→

2

↓ <SET>

Response time setting mode

Set the response time using <ITEM/Δ>,<SET>+<ITEM/Δ>.

(1 to 99ms)

Increase
 Decrease

↓ <SET>
Monitor

4.2.4 Mode 4

(Mode for setting of each parameter for optional function)

The mode with (※) mark can be set to each unit.

Auto-off setting mode **OFF**

Display LCD turns off automatically when there is no key operation for a long time.

- Off time can be set the range of 0 to 99min.
- “0” should be set if you want to turn always light on.
- “1 to 99” should be set if you want to turn light off at setting time.
- After turns off the LCD, any key operation makes it turns on.





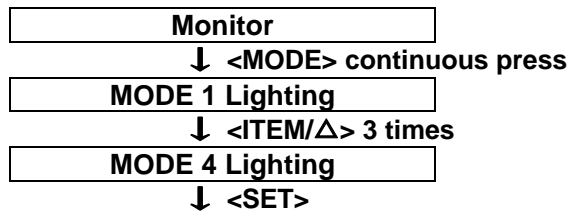

Version check mode (※) **VER**

Mode to check version of the software.

It displays version of the software.

MODE4 Setting flow chart



Auto-off setting mode					
Set auto-off time by minute using <ITEM/Δ>,<SET>+<ITEM/Δ>.					
 (0 to 99 min.)	<table border="1" style="margin: auto; border-collapse: collapse;"> <tr> <td style="text-align: center; padding: 5px;"></td> <td style="padding: 5px;">Increase</td> </tr> <tr> <td style="text-align: center; padding: 5px;"></td> <td style="padding: 5px;">Decrease</td> </tr> </table>		Increase		Decrease
	Increase				
	Decrease				
“0” should be set to turn always light on. “1 to 99” should be set to turn light off at setting time (minute). While light off, press any key to light on.					

↓ <SET>

Version check mode (※)	
It displays the version of software.	
	

↓ <SET>

Monitor

Chapter 5 Various Functions

5.1 LOCK mode

It is the mode makes all keys unable. Use when you want to fix one of the measurement displays (For all displays). In this mode, you can not input by any keys.

When you press <SET> continuously for about 3sec., the "LOCK" lights and all keys become locked (pressing them will have no effect).

Press <SET> continuously for about 3sec. again to release Lock mode. The "LOCK" indicator goes off and the lock mode is released (unlocked).

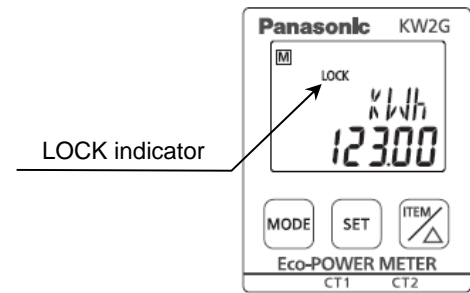

5.2 Pulse output function

Refer to the mode 1 setting for the way to set.

"OUT" is lighting when pulse output.

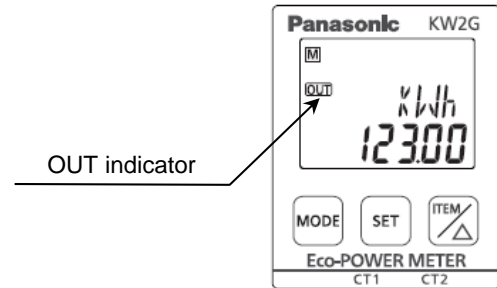

5.2.1 Output depends on integrated electric power

Set the unit for pulse output (0.001/0.01/0.1/1/10/100kWh) and pulse output (transistor output) turns on every time when integrated electric power reaches the unit. (Pulse width: about 100ms)

5.2.2 Instantaneous electric power alarm

When it exceeds the setting instantaneous electric power, pulse output (transistor output) turns on in order to notice. When it falls below, the output turns off.

5.2.3 Current alarm

When it exceeds the setting current ratio, pulse output (transistor output) turns on in order to notice. When it falls below, the output turns off.

5.2.4 Stand-by power alarm

When it detects stand-by power (current) of the measured load, pulse output (transistor output) turns on in order to notice.

Set current (C) and stand-by time (T) to judge stand-by power.

When the measured load is satisfied the setting conditions, pulse output (transistor output) turns on in order to notice.

When it exceeds the setting value, it turns off and reset it.

You can reset the alarm by pressing <SET> with the instantaneous electric power display.

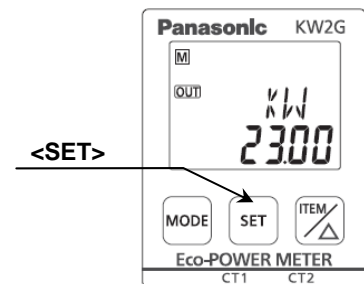

(Working flow chart)

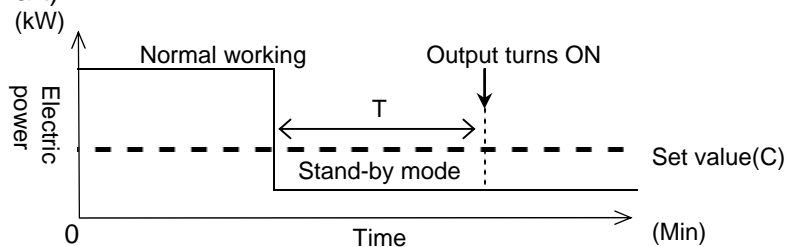

5.2.5 Output depends on count value

Set the preset value and pulse output (transistor output) turns on the time when count value reaches the preset value.

Refer to the next in detail.

5.3 Counter function

● Operation mode

Maintain output hold count **HOLD**

[Output]  OFF ON

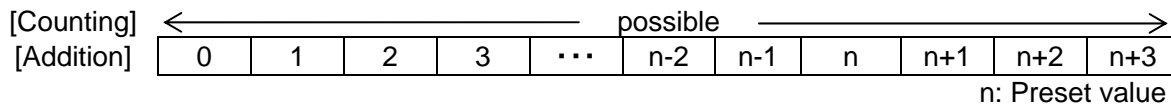

- (1) Output control is maintained after count-up completion and until reset. However counting is possible despite of count-up completion.
- (2) It reverts "0" after counting up full scale, but output control is maintained. However output is OFF if count value or preset value is changed.

● Change the Preset Value

It is possible to change the preset value even during counting. However note the following points.

◇ When the pre-scale value is "1.000". (PSCL=1.000)

- (1) If the preset value is changed to the value less than the count value, counting will continue until it reaches full scale, returns to "0" and then reaches the new preset value.
- (2) If the preset value is changed to "0", it will not count up at start with "0". It counts up when the counting value comes to "0" again (after reach to full scale). However output is OFF if count value or preset value is changed.
- (3) When the count value is fixed, output is changed according to the changing of preset value as below.
 - ① If the preset value is changed to the value less than the count value or same as count value, output is ON.
(Count value \geq Preset value)
 - ② If the preset value is changed to the value more than the count value, output is OFF.
(Count value $<$ Preset value)

◇ When the pre-scale is not "1.000". (PSCL \neq 1.000)

Even if the preset value is changed after counting to full scale, output is not changed.

Chapter 6 Display of each Value

6.1 Working of Monitor Display

Single-phase two-wire system

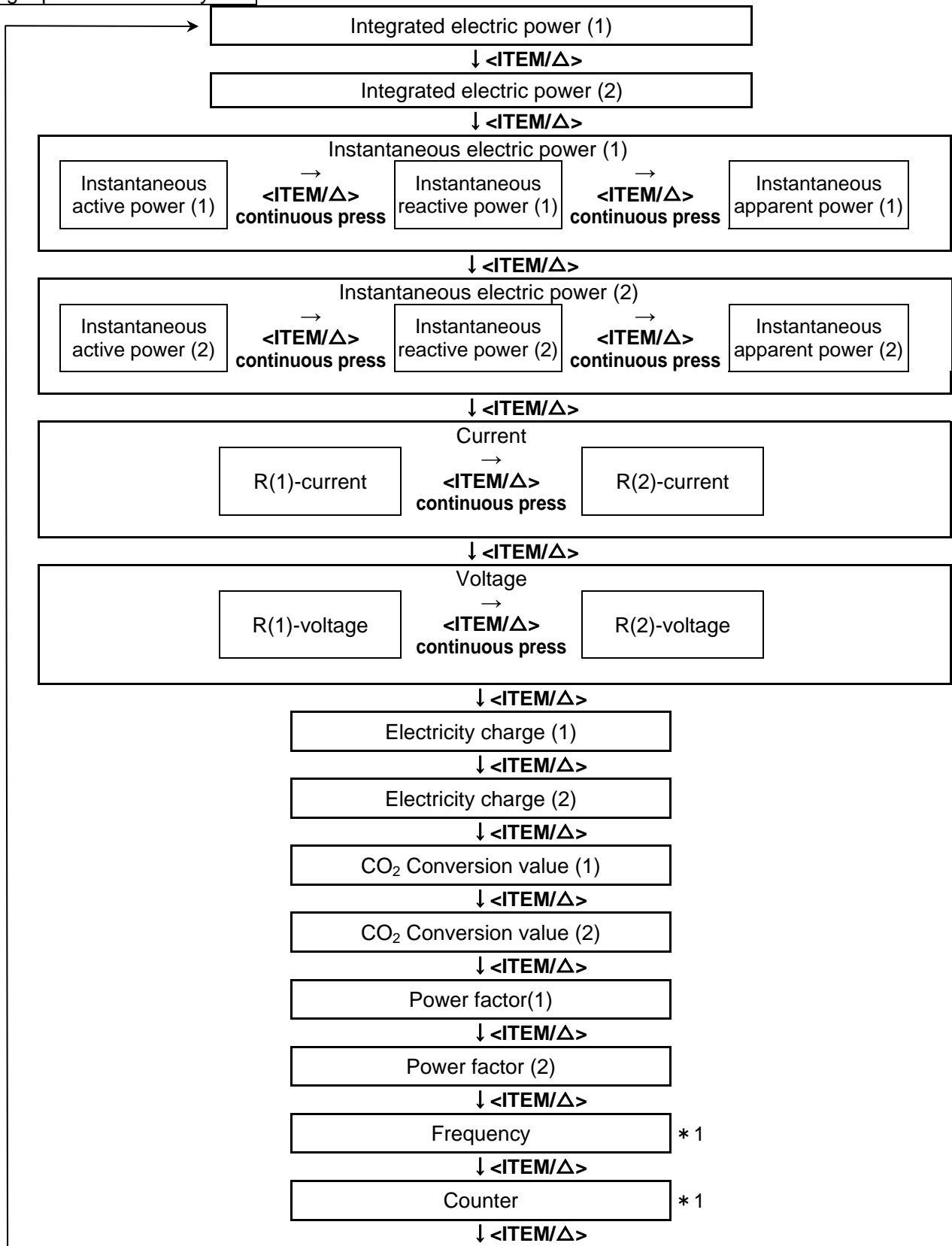

Displayed item is shifted to the other direction by pressing <ITEM/Δ> during pressing <SET>.

* 1 Display of frequency and counter is common to all units.

(1), (2) of each item means as below.

Integrated electric power (1)	Integrated electric power calculated by voltage between P1-P0 and detected current by CT1
Integrated electric power (2)	Integrated electric power calculated by voltage between P2-P0 and detected current by CT2
Instantaneous electric power (1)	Instantaneous electric power from voltage between P1 - P0 and detected current by CT1
Instantaneous electric power (2)	Instantaneous electric power from voltage between P2 - P0 and detected current by CT2
R(1)-current	Detected current by CT1
R(2)-current	Detected current by CT2
R(1)-voltage	Voltage between P1 and P0
R(2)-voltage	Voltage between P2 and P0
Electricity charge (1)	Electricity charge for integrated electric power(1)
Electricity charge (2)	Electricity charge for integrated electric power(2)
CO ₂ Conversion value (1)	CO ₂ Conversion value for integrated electric power(1)
CO ₂ Conversion value (2)	CO ₂ Conversion value for integrated electric power(2)
Power factor (1)	Power factor of Instantaneous electric power(1)
Power factor (2)	Power factor of Instantaneous electric power(2)

Single-phase three-wire system/Three-phase three-wire system

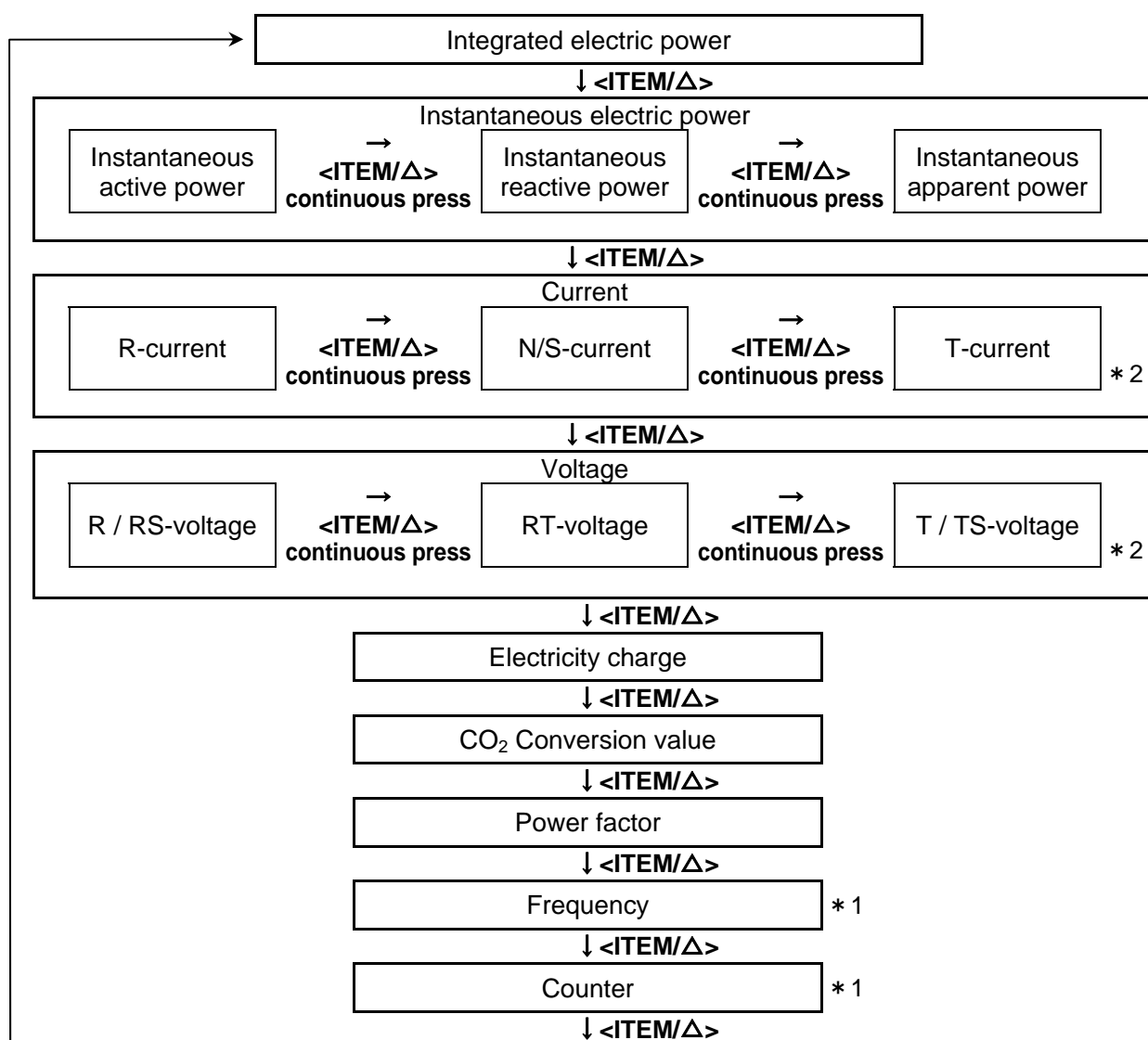

Displayed item is shifted to the other direction by pressing <ITEM/Δ> during pressing <SET>.

* 1 Display of frequency and counter is common to all units.

* 2 Display is changed according to the phase/wire system.

	Current	Voltage
Single-phase three-wire system	R-current, N-current, T-current	R-voltage, RT-voltage, T-voltage (P1-P0) (P1-P2) (P2-P0)
Three-phase three-wire system	R-current, S-current, T-current	RS-voltage, RT-voltage, TS-voltage (P1-P0) (P1-P2) (P2-P0)

6.2 Display of each measurement value (Common to main unit and expansion unit)

【Unit change】

Press <MODE> to shift display of main unit (M) and expansion units (1 to 7).

Main unit **M** Lighting Expansion unit **1** **2** **3** to **7** Lighting

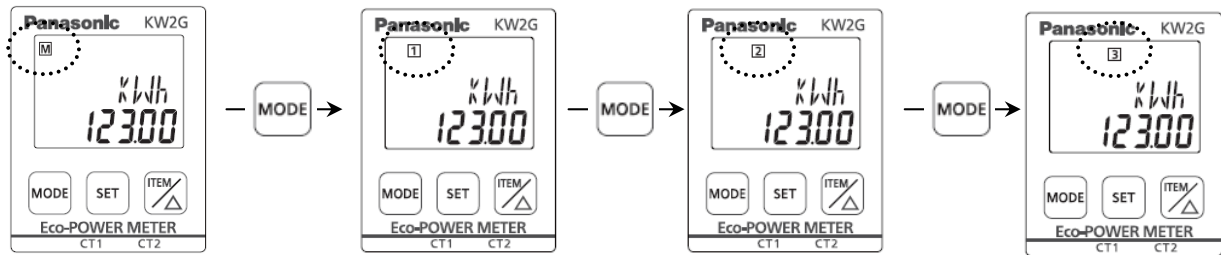

6.2.1 Integrated electric power

• It displays the integrated electric power.

Example of 1P2W

Integrated electric power (1)[1.kWh/1.MWh] is displayed first and press <ITEM/Δ> to display integrated electric power (2)[2.kWh/2.MWh].

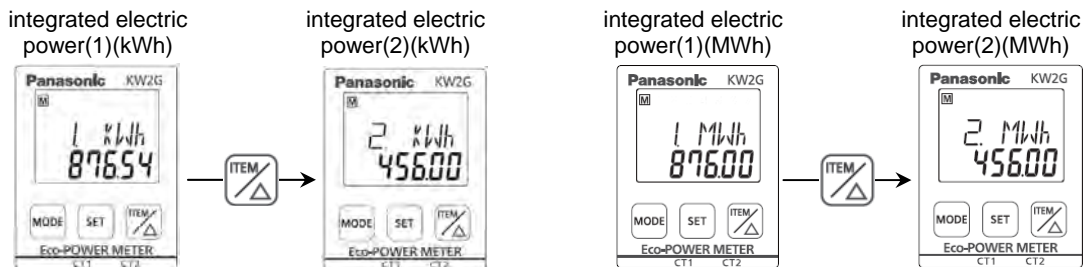

Example of 1P3W/3P3W

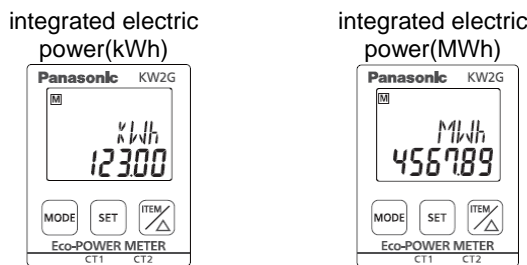

- Integrated electric power is measured and displayed from 0.00kWh to 9999.99MWh.
- The decimal point is changed automatically.

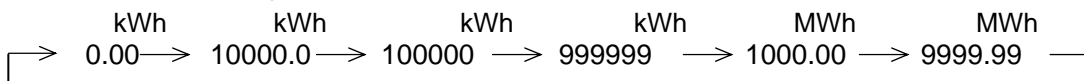

(After reaching the full scale (99999.9kWh), the value reverts to 0.00kWh but continues to measure.)

How to reset

• Hold down <SET> and press <MODE> makes integrated electric power clear.

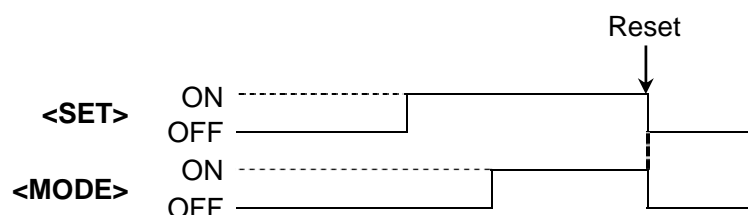

How to display with 9-digit

Integrated electric power can be displayed with 9-digit.

- Press <MODE> during pressing <ITEM/Δ> at integrated electric power display (kWh/MWh) and integrated electric power with 9-digit (kWh) is displayed.

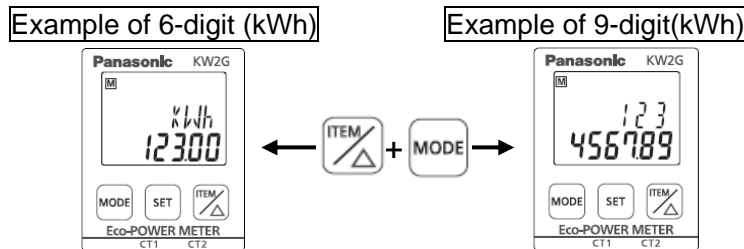

6.2.2 Instantaneous electric power

- It displays the instantaneous electric power.
- Press <ITEM/Δ> continuously to shift display, instantaneous active power(kW), instantaneous reactive power (kvar) and instantaneous apparent power (kVA).

Example of 1P2W

Instantaneous active power (1)[1.kW] is displayed first and press <ITEM/Δ> to display instantaneous active power (2)[2.kW].

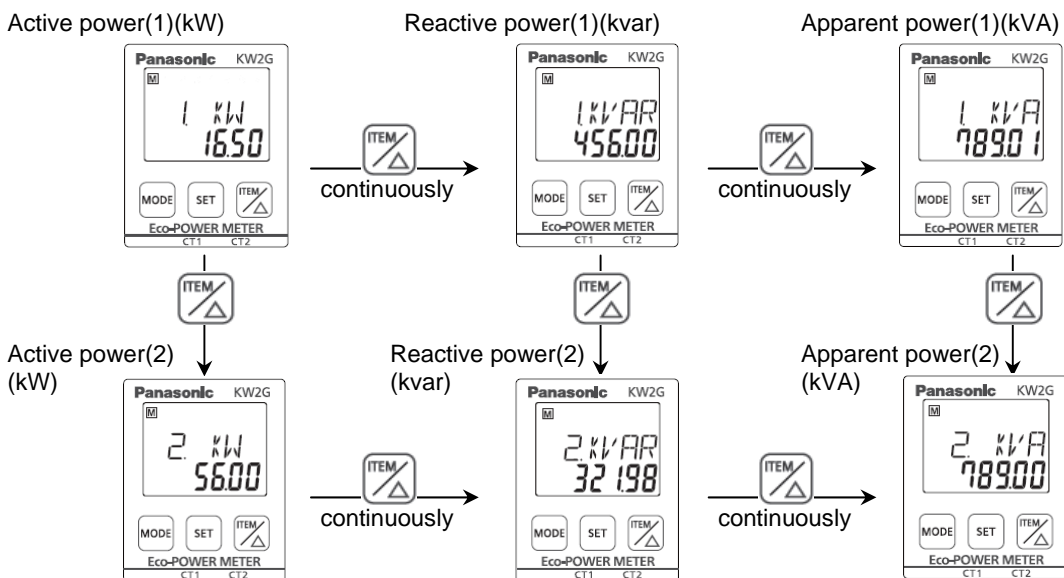

Example of 1P3W/3P3W

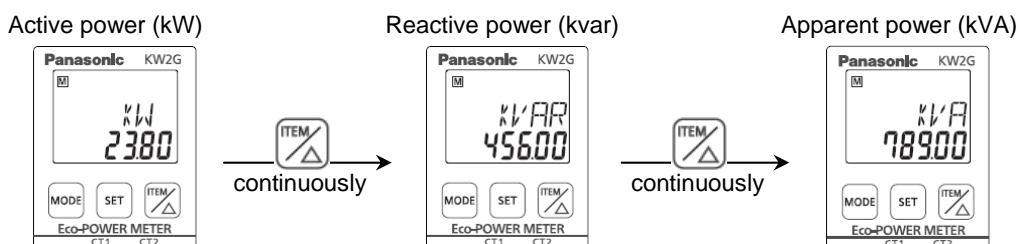

- It determines plus or minus of instantaneous reactive power by the input measuring voltage and the input measuring current. When harmonics or a wave pattern is warped, it may not determine correctly.

6.2.3 Current

- It displays the current value.
- Press <ITEM/Δ> continuously to shift the display.
- * When the display is different from the measured load system, set to the correct system at the setting mode. (Refer to 4.2.1 Phase/wire setting mode.)

Example of 1P2W

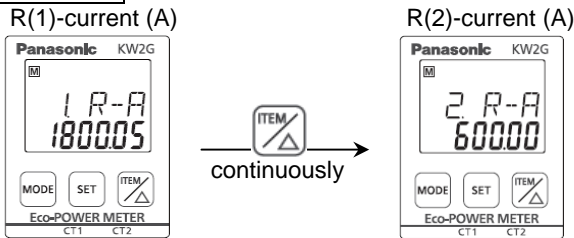

Example of 1P3W

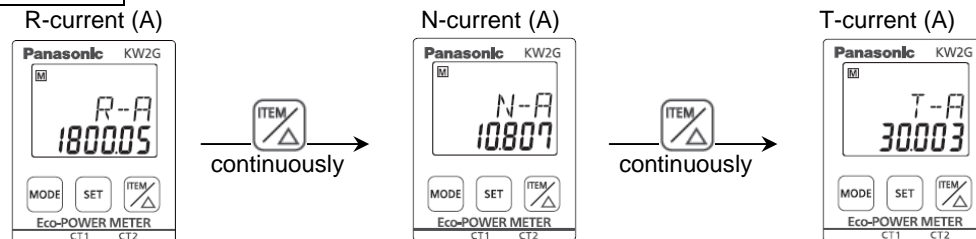

Example of 3P3W

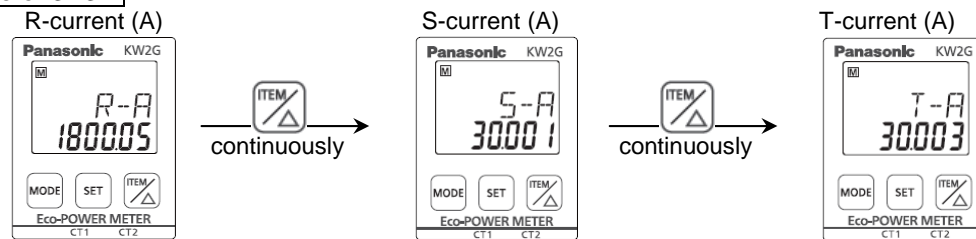

- When input current exceeds 150%F.S. at each range, 「 - - - - - 」 will be displayed.
- Current measurement parts

Eco-POWER METER measures the current as below.

System	Display	1.R-A / R-A	N-A / S-A	2.R-A / T-A
Single-phase two-wire system		R-current	—	R-current
Single-phase three-wire system		R-current	N-current	T-current
Three-phase three-wire system		R-current	S-current	T-current

6.2.4 Voltage

- It displays the voltage value.
- Press <ITEM/Δ> continuously to shift the display.
- * When the display is different from the measured load system, set to the correct system at the setting mode. (Refer to 4.2.1 Phase/wire setting mode.)

Example of 1P2W

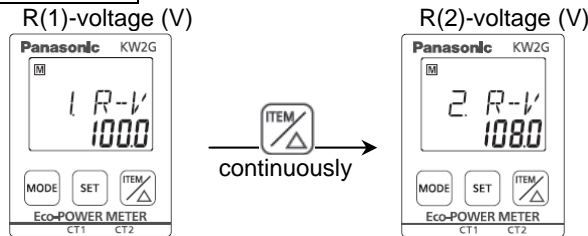

Example of 1P3W

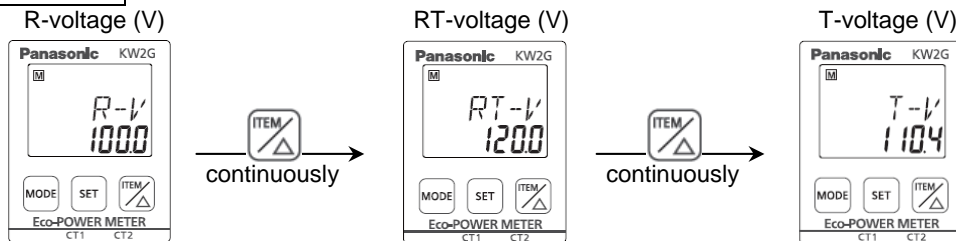

Example of 3P3W

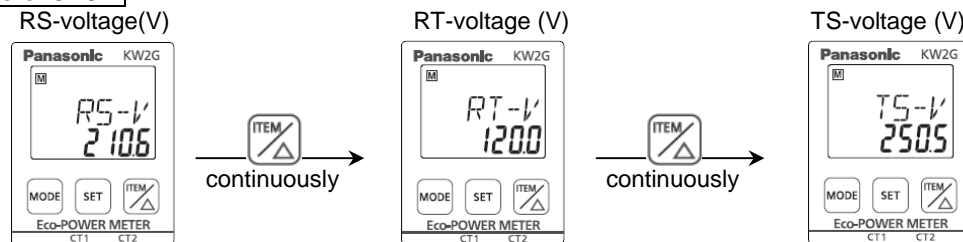

- When input voltage is under 5% of rating, it displays “0.0” and doesn’t measure.
 (“Under 5%” means the value getting from this calculation “rated voltage 200(400) x 0.05 x VT ratio”.)
- When input voltage exceeds 150%F.S. at each range, 「 - - - - - 」 will be displayed.
- Voltage measurement parts

Eco-POWER METER measures the voltage as below.

System \ Display	1.R-V / R-V / RS-V	RT-V	2R-V / T-V / TS-V
Single-phase two-wire	R(1)-voltage (Between P1 and P0) (Line voltage)	—	R(2)-voltage (Between P2 and P0) (Line voltage)
Single-phase three-wire	R-voltage (Phase voltage)	RT-voltage (Between P1 and P2) (Line voltage)	T-voltage (Phase voltage)
Three-phase three-wire	RS-voltage (Between P1 and P0) (Line voltage)	RT-voltage (Between P1 and P2) (Line voltage)	TS-voltage (Between P2 and P0) (Line voltage)

6.2.5 Electricity Charge

• It displays the standard electricity charge for the integrated electrical power.

Example of 1P2W

Electricity charge(1)[1.CHG] is displayed first and press <ITEM/Δ> to display electricity charge(2)[2.CHG].

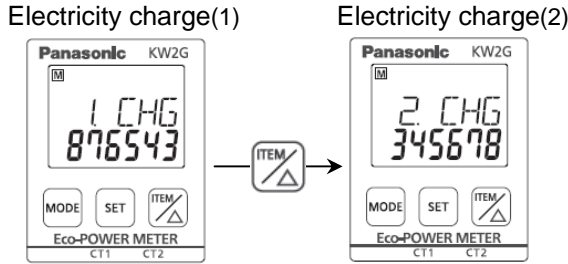

Example of 1P3W/3P3W

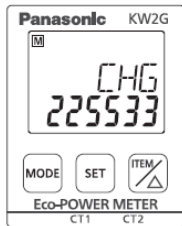

• When the value exceeds '999999', 「- - - - -」 will be displayed.

6.2.6 Carbon dioxide conversion value

• It displays the standard conversion value for the integrated electrical power.

Example of 1P2W

CO₂ conversion value(1)[1.CO₂] is displayed first and press <ITEM/Δ> to display CO₂ conversion value (2) [2.CO₂].

CO₂ conversion value(1) CO₂ conversion value(2)

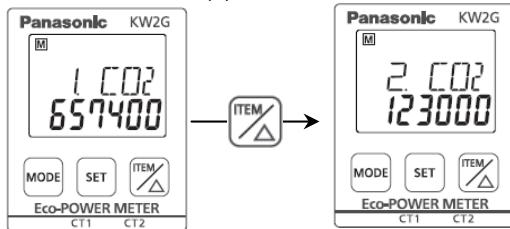

Example of 1P3W/3P3W

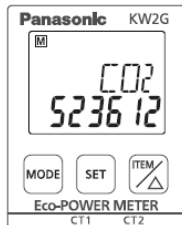

• When the value exceeds '999999', 「- - - - -」 will be displayed.

6.2.7 Power factor

• It displays power factor of the load.

Example of 1P2W

Power factor (1)[1.PF] is displayed first and press <ITEM/Δ> to display power factor (2)[2.PF].

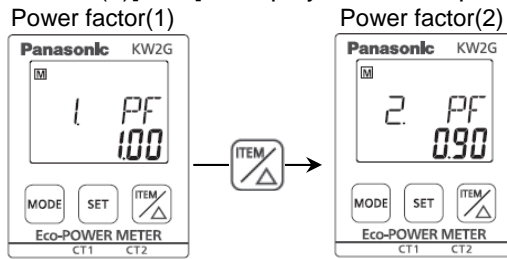

Example of 1P3W/3P3W

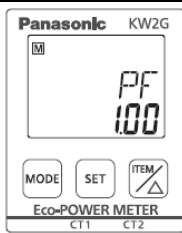

• It displays minus value when it detects the regeneration electric power. (Ex.: -1.00)

• How to calculate power factor

Eco-POWER METER displays power factor by calculating as below.

Single-phase two-wire	$PF = \frac{\text{Instantaneous electric power}}{\text{Voltage} \times \text{Current}}$
Single-phase three-wire	$PF = \frac{\text{Instantaneous electric power}}{2 \times \left(\text{Average of each phase V} \right) \times \left(\text{Average of each phase A} \right)}$
Three-phase three-wire	$PF = \frac{\text{Instantaneous electric power}}{\sqrt{3} \times \left(\text{Average of each phase V} \right) \times \left(\text{Average of each phase A} \right)}$

6.2.8 Frequency

• It displays the frequency of the voltage between P1 and P0.

Example

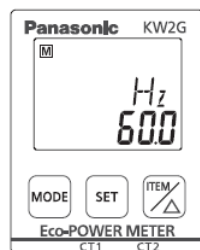

6.2.9 Counter

• It displays present count value (pulse input value).

Example

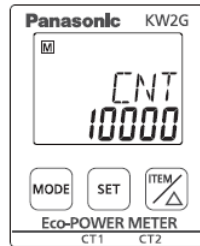

How to Reset Count value

• At counter display, holding down <SET> and <MODE> continuously makes count value clear.

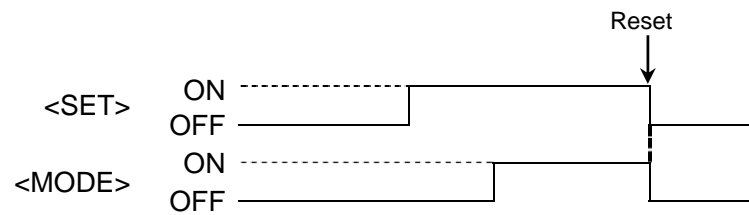

6.3 Other indication

6.3.1 Indication while communication

TX/RX indicator is blinking while Eco-POWER METER is under communication.

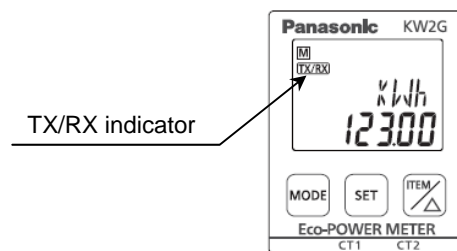

Chapter 7 Communication

7.1 Communication Procedures

Communication starts with command transmission from the host computer (hereafter Master) and ends with the response of Eco-POWER METER (hereafter Slave).

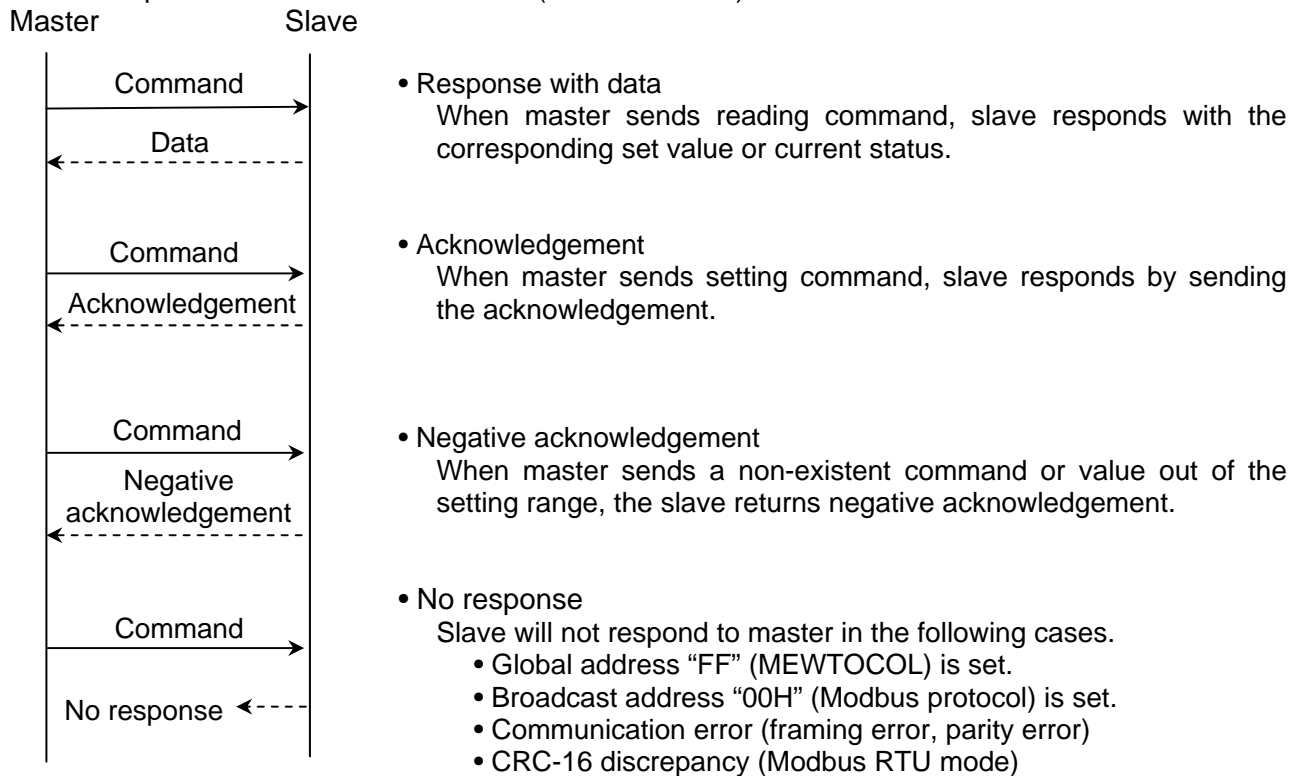

7.2 Communication timing

◆ The minimum access time from the master is 0.1 sec. (Minimum time for update the data)
Eco-POWER METER may not response due to noise and so on, be sure to check that it receives the response from Eco-POWER METER.

◆ In order to improve the communication quality, we recommend to send the transmission again.

Communication timing of RS485

◇Eco-POWER METER (Slave) side

When Eco-POWER METER (Slave) starts transmission to RS485 communication line, it is arranged so as to provide an idle status transmission period of about 1 to 99ms (setting available) before sending the response to ensure the synchronization on the receiving side. After sending the response, master can disconnect the transmitter from the communication line within transmission period 20ms.

◇Master side (Cautions of setting a program)

At communication, keep the following conditions.

- 1) Set the program so that the master can disconnect the transmitter from the communication line within the transmission period of about 2ms after sending the command in preparation for reception of the response from Eco-POWER METER (Slave).
- 2) To avoid collision of transmissions between the master and Eco-POWER METER (Slave), send a next command after checking that the master received the response.

7.3 MEWTOCOL Communication

7.3.1 Overview of MEWTOCOL-COM (RS485, USB)

◆ Command and response functions

The computer sends commands (instructions) to Eco-POWER METER, and receives responses in return. This enables the computer and Eco-POWER METER to converse with each other, so that various kinds of information can be obtained and provided.

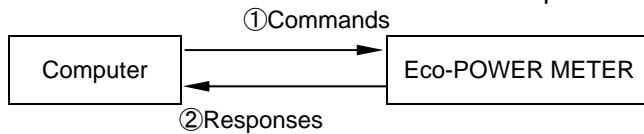

◆ Command and response formats

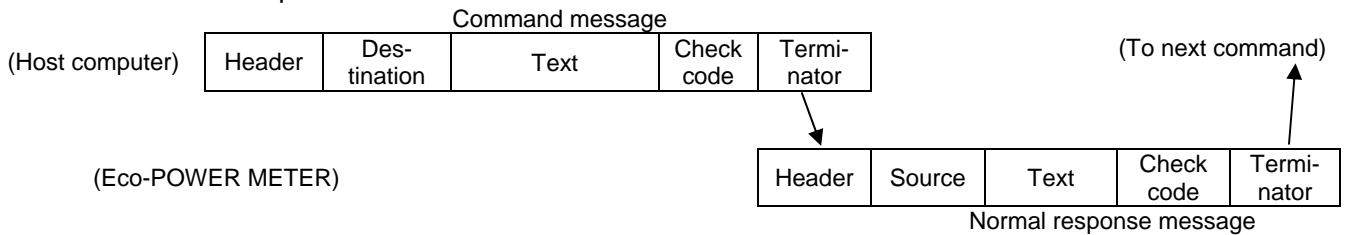

◇ Control codes

Name	Character	ASCII code	Explanation
Header	%	25H	Indicates the beginning of a message.
Command	#	23H	Indicates that the data comprises a command message.
Normal response	\$	24H	Indicates that the data comprises a normal response message.
Error response	!	21H	Indicates that the data comprises a response message when an error occurs.
Terminator	CR	0DH	Indicates the end of a message.

◇ Destination and source AD (H), (L)

Two-digit decimal 01 to 99 (ASCII codes)

Command messages contain a station number for Eco-POWER METER that receives the message. When FF (ASCII code table) is used, however, the transmission is a global transmission (sent to all stations at once).

Note) When a global transmission is sent, no response to the command message is returned.

◇ Block check code Bcc (H), (L)

Two-digit hexadecimal 00 to FF (ASCII codes)

These are codes (horizontal parity) that are used to detect errors in the transmitted data.

If “**” is entered instead of “Bcc”, however, messages can be transmitted without the Bcc. In this case, the Bcc is included with the response

◇ Error code Err (H), (L)

Two-digit hexadecimal 00 to FF (ASCII codes)

These indicate the content if an error occurs.

◆ Bcc (Block Check Code)

-The Bcc is a code that carries out an error check using horizontal parity, to improve the reliability of the data being sent.

-The Bcc uses an exclusive OR from the header (%) to the final character of the text, and converts the 8-bit data into a 2-character ASCII code.

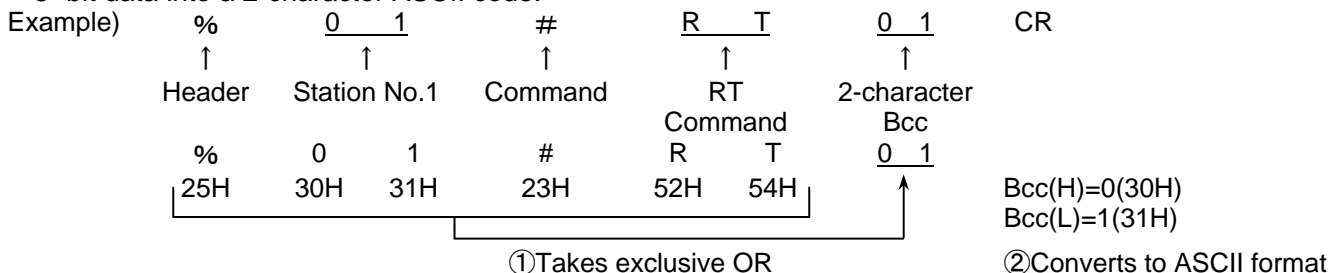

7.3.2 Data Register List (MEWTOCOL)

【M】:Main unit 【E *】:Expansion unit Registers without 【】 are common.

Data register	Name	Unit	Kind of data	Range	R/W
DT00020	【M】CT type	Rated A(rms)	Unsigned 16bit	6 types: 5,50,100,250,400,600	R/W
DT00021	【E1】CT type	Rated A(rms)	Unsigned 16bit		
DT00022	【E2】CT type	Rated A(rms)	Unsigned 16bit		
DT00023	【E3】CT type	Rated A(rms)	Unsigned 16bit		
DT00024	【E4】CT type	Rated A(rms)	Unsigned 16bit		
DT00025	【E5】CT type	Rated A(rms)	Unsigned 16bit		
DT00026	【E6】CT type	Rated A(rms)	Unsigned 16bit		
DT00027	【E7】CT type	Rated A(rms)	Unsigned 16bit	1 to 500	R/W
DT00030	【M】Cutoff current	0.10%	Unsigned 16bit		
DT00031	【E1】Cutoff current	0.10%	Unsigned 16bit		
DT00032	【E2】Cutoff current	0.10%	Unsigned 16bit		
DT00033	【E3】Cutoff current	0.10%	Unsigned 16bit		
DT00034	【E4】Cutoff current	0.10%	Unsigned 16bit		
DT00035	【E5】Cutoff current	0.10%	Unsigned 16bit		
DT00036	【E6】Cutoff current	0.10%	Unsigned 16bit	1 to 4000	R/W
DT00037	【E7】Cutoff current	0.10%	Unsigned 16bit		
DT00040	【M】Primary side current value when CT 5A	1A	Unsigned 16bit		
DT00041	【E1】Primary side current value when CT 5A	1A	Unsigned 16bit		
DT00042	【E2】Primary side current value when CT 5A	1A	Unsigned 16bit		
DT00043	【E3】Primary side current value when CT 5A	1A	Unsigned 16bit		
DT00044	【E4】Primary side current value when CT 5A	1A	Unsigned 16bit		
DT00045	【E5】Primary side current value when CT 5A	1A	Unsigned 16bit	0 to 9999	R/W
DT00046	【E6】Primary side current value when CT 5A	1A	Unsigned 16bit		
DT00047	【E7】Primary side current value when CT 5A	1A	Unsigned 16bit		
DT00054	Rate (CHG)	0.01	Unsigned 16bit	0 to 9999	R/W
DT00055	Conversion factor (CO2)	0.001 kg-CO ₂	Unsigned 16bit	0 to 9999	R/W
DT00056	Simple measuring	—	Unsigned 16bit	0:OFF 1:ON	R/W
DT00057	Simple voltage	0.1V	Unsigned 32bit	0 to 99999	R/W
DT00058					
DT00059	Simple PF	0.01	Unsigned 16bit	0 to 100	R/W
DT00061	Unit for Pulse output	—	Unsigned 32bit	1(0.001),10(0.01),100(0.1),1000(1),10000(10),100000(100) 999 (Instantaneous electric power: Values of DT00064, 00065) 777 (Ratio for current alarm: Value of DT00069) 555 (Preset value for output: Values of DT00158,00159) 333 (Ratio and time for Stand-by alarm: Value of DT00077,00078)	R/W
DT00062					
DT00064	Power alarm value (Instantaneous electric power)	0.01kW	Unsigned 32bit	0 to 999999	R/W
DT00065					
DT00066	VT ratio	0.01	Unsigned 16bit	100 to 9999	R/W
DT00068	Cutoff current	0.1%	Unsigned 16bit	1 to 500	R/W
DT00069	Ratio for current alarm	0.1%	Unsigned 16bit	10 to 1000	R/W
DT00070	Voltage range	—	Unsigned 16bit	2; 200V (Fixed)	R

Data register	Name	Unit	Kind of data	Range	R/W
DT00077	Ratio for stand-by current	0.1%	Unsigned 16bit	1 to 1000	R/W
DT00078	Time for stand-by alarm	1 min.	Unsigned 16bit	0 to 9999	R/W
DT00086 Upper	【M】Shift average frequency	—	Unsigned16bit	5 types: 0,2,4,8,16	R/W
DT00086 Lower	【E1】Shift average frequency				
DT00087 Upper	【E2】Shift average frequency	—	Unsigned16bit		
DT00087 Lower	【E3】Shift average frequency				
DT00088 Upper	【E4】Shift average frequency	—	Unsigned16bit		
DT00088 Lower	【E5】Shift average frequency				
DT00089 Upper	【E6】Shift average frequency	—	Unsigned16bit		
DT00089 Lower	【E7】Shift average frequency				
DT00158	Preset value	—	Unsigned 32bit	0 to 999999	R/W
DT00159					
DT00160	Prescale value	0.001	Unsigned 32bit	1 to 100000	R/W
DT00161					
DT00162	Max. counting speed	Hz	Unsigned 16bit	50000 or 30	R/W
DT00163	Auto-off time	min	Unsigned 16bit	0 to 99 (0:always on)	R/W

Measurement value

Data register	Name	Unit	Kind of data	Range	R/W
DT{(N+1) * 100}	Integrated active power ((1))	0.01kWh	Unsigned32bit	0 to 999999999	R/W
DT{(N+1) * 100}+1					
DT{(N+1) * 100}+11	Power factor ((1))	0.01	Signed 16bit	-100 to 100	R
DT00112	Frequency	0.1Hz	Unsigned 16bit	0 to 1000	R
DT{(N+1) * 100}+13	Power factor (2) * 1	0.01	Signed 16bit	-100 to 100	R
DT{(N+1) * 100}+20	Integrated active Power ((1))	0.01kWh	Unsigned 32bit	0 to 999999999	R/W
DT{(N+1) * 100}+21					
DT{(N+1) * 100}+22	Integrated active power (2) * 1	0.01kWh	Unsigned 32bit	0 to 999999999	R/W
DT{(N+1) * 100}+23					
DT{(N+1) * 100}+24	Voltage (R/RS)	0.1V	Unsigned 32bit	0 to 999999	R
DT{(N+1) * 100}+25					
DT{(N+1) * 100}+26	Voltage (RT)	0.1V	Unsigned 32bit	0 to 999999	R
DT{(N+1) * 100}+27					
DT{(N+1) * 100}+28	Voltage (T/TS) * 1	0.1V	Unsigned 32bit	0 to 999999	R
DT{(N+1) * 100}+29					
DT{(N+1) * 100}+34	Current (R)	0.001A	Unsigned 32bit	0 to 60000000	R
DT{(N+1) * 100}+35					
DT{(N+1) * 100}+36	Current (N/S)	0.001A	Unsigned 32bit	0 to 60000000	R
DT{(N+1) * 100}+37					
DT{(N+1) * 100}+38	Current (T) * 1	0.001A	Unsigned 32bit	0 to 60000000	R
DT{(N+1) * 100}+39					
DT{(N+1) * 100}+40	Instantaneous active power((1))	0.1W	Signed 32bit	-999999 to 999999	R
DT{(N+1) * 100}+41					
DT{(N+1) * 100}+42	Instantaneous active power(2) * 1	0.1W	Signed 32bit	-999999 to 999999	R
DT{(N+1) * 100}+43					
DT00154	Pulse count value	—	Unsigned 32bit	0 to 999999	R/W
DT00155					

Data register	Name	Unit	Kind of data	Range	R/W
DT{(N+1) * 100}+70	Voltage (R/RS)	0.1V	Unsigned 32bit	0 to 999999	R
DT{(N+1) * 100}+71					
DT{(N+1) * 100}+72	Voltage (RT)	0.1V	Unsigned 32bit	0 to 999999	R
DT{(N+1) * 100}+73					
DT{(N+1) * 100}+74	Voltage (T/TS) * 1	0.1V	Unsigned 32bit	0 to 999999	R
DT{(N+1) * 100}+75					
DT{(N+1) * 100}+76	Instantaneous active power ((1))	0.01 kW	Signed 32bit	-999999 to 999999	R
DT{(N+1) * 100}+77					
DT{(N+1) * 100}+78	Instantaneous reactive power ((1))	0.01 kvar	Signed 32bit	-999999 to 999999	R
DT{(N+1) * 100}+79					
DT{(N+1) * 100}+80	Instantaneous apparent power ((1))	0.01 kVA	Unsigned 32bit	0 to 999999	R
DT{(N+1) * 100}+81					
DT{(N+1) * 100}+82	Instantaneous active power (2) * 1	0.01 kW	Signed 32bit	-999999 to 999999	R
DT{(N+1) * 100}+83					
DT{(N+1) * 100}+84	Instantaneous reactive power (2) * 1	0.01 kvar	Signed 32bit	-999999 to 999999	R
DT{(N+1) * 100}+85					
DT{(N+1) * 100}+86	Instantaneous apparent power(2) * 1	0.01 kVA	Unsigned 32bit	0 to 999999	R
DT{(N+1) * 100}+87					

N: Unit number Main unit: N=0 Expansion unit: N=1 to 7

Data of 2nd circuit of single-phase two-wire system will be entered in name with * 1.

Note1) R: Read W: Write

2) Data register except specified is 0.

3) DT00061, 00062 (Unit for pulse output) is numerical value (in the range of data register).

4) If each setting value is wrote by communication, it memories to internal EEPROM at the same time. Therefore, change setting frequently makes EEPROM's life short. Avoid to usage like this.

5) Write a data within the range when you write it.

6) Max reading point is 26 points (57 bites), max writing point is 23 points (55 bites).

7.3.3 Error Codes

◇Basic procedure errors

Error code	Error name	Explanation
40H	Bcc error	• A Bcc error occurred in the command data.
41H	Format error	• A command message was sent that does not fit the transmission format.
42H	No support error	• A command was sent that is not supported.
43H	Procedure error	• Delimiter with multiple frames was sent. • The response shall be multiple frames.

◇Application error

Error code	Error name	Explanation
60H	Parameter error	• The data code is not "D".
61H	Data error	• Word No. is specified without decimal. (0000F etc.) • The starting word No. is bigger than the ending word No. • Writing data has a code that is not hexadecimal.
62H	Registration error	• Too many registrations have been entered (more than 17). • "MD" command was sent when some registration has been exist. • "MG" command was sent when registration has not been entered.

◇Self-diagnostic error

Error code	Error name	Explanation
45H	Operation error	• At "WD" command, writing data is exceeded the range of data register.

7.3.4 Command

Eco-POWER METER has 5 kinds of commands.

Command name	Code	Explanation
Read data area	RD	Reads the contents of data area.
Write data to data area	WD	Writes data to a data area.
Resister or Reset data monitored	MD	Resisters the data to be monitored.
Monitoring start	MG	Monitors a registered data.
Read status	RT	Reads the specifications of Eco-POWER METER and error code if an error occurs.

◆[RD]: Read data area (Reads the contents of data area.)

◇Command

%	Destination $\times 10^1$ $\times 10^0$	#	R	D	D	Starting word No. 5 characters $\times 10^4$ $\times 10^3$ $\times 10^2$ $\times 10^1$ $\times 10^0$					Ending word No. 5 characters $\times 10^4$ $\times 10^3$ $\times 10^2$ $\times 10^1$ $\times 10^0$					Bcc $\times 16^1$ $\times 16^0$	CR
---	--	---	---	---	---	--	--	--	--	--	--	--	--	--	--	--------------------------------------	----

◇Normal response (Read successful)

%	Source $\times 10^1$ $\times 10^0$	\$	R	D	First register contents 4 characters $\times 16^1$ $\times 16^0$ $\times 16^3$ $\times 16^2$				Last register contents 4 characters $\times 16^1$ $\times 16^0$ $\times 16^3$ $\times 16^2$				Bcc $\times 16^1$ $\times 16^0$	CR
					(lower word) (higher word)				(lower word) (higher word)					

◇Error response

%	Source $\times 10^1$ $\times 10^0$!	Error code $\times 16^1$ $\times 16^0$	Bcc $\times 16^1$ $\times 16^0$	CR	(Common to each command)
---	---	---	---	--------------------------------------	----	--------------------------

◆[WD]: Write data area (Writes date to a data area.)

◇Command

%	Destination $\times 10^1$ $\times 10^0$	#	W	D	D	Starting word No. 5 characters $\times 10^4$ $\times 10^3$ $\times 10^2$ $\times 10^1$ $\times 10^0$					Ending word No. 5 characters $\times 10^4$ $\times 10^3$ $\times 10^2$ $\times 10^1$ $\times 10^0$					First writing data 4 characters $\times 16^1$ $\times 16^0$ $\times 16^3$ $\times 16^2$				⇒			
															(lower word) (higher word)				(lower word) (higher word)				

◇Normal response (Write successful)

%	Source $\times 10^1$ $\times 10^0$	\$	W	D	Bcc $\times 16^1$ $\times 16^0$	CR	⇒	Last writing data 4 characters $\times 16^1$ $\times 16^0$ $\times 16^3$ $\times 16^2$				Bcc $\times 16^1$ $\times 16^0$	CR		
								(lower word) (higher word)				(lower word) (higher word)			

◆[MD]: Register or Reset data monitored (Registers the data to be monitored.) *Up to 16 points can be registered for one unit.

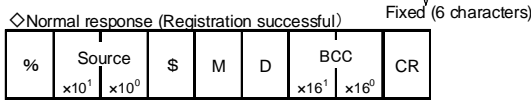
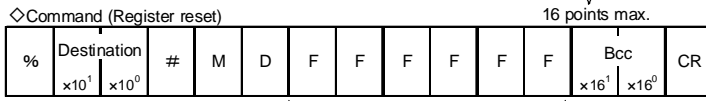
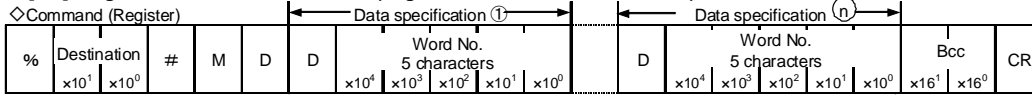

◆[MG]: Monitoring start (Monitors a registered data.)

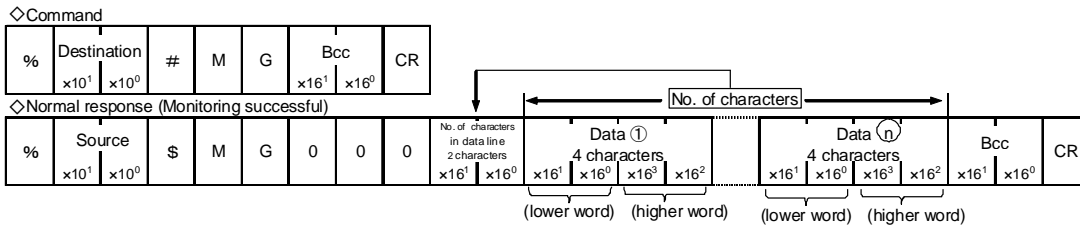

◆[RT]: Read the status of Eco-POWER METER (Reads the specifications of Eco-POWER METER and error codes if an error occurs.)

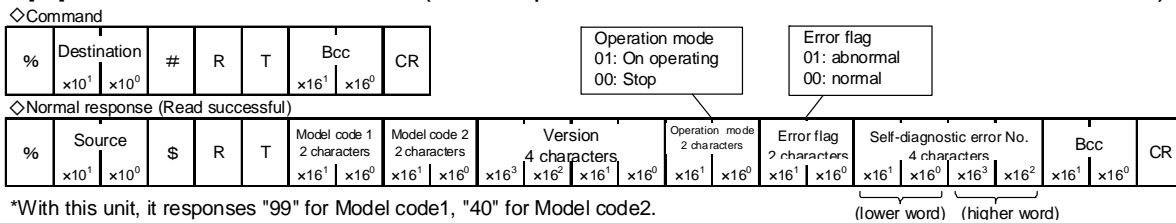

*With this unit, it responds "99" for Model code1, "40" for Model code2.

7.4 MODBUS (RTU) Communication

7.4.1 Overview of MODBUS (RTU)

◆8-bit binary data in command is transmitted as it is.

Data format	Start bit	: 1 bit
	Data bit	: 8 bits *7bits is not available.
	Parity	: No parity, Even parity, Odd parity Selectable
	Stop bit	: 1 bit (Fixed)
	Error detection	: CRC-16 (Cyclic Redundancy Check)
	Data interval	: 3.5 character transmission time or less

◆Message configuration

RTU mode is configured to start after idle time processing of more than 3.5 character transmissions and end after idle time processing of more than 3.5 character transmissions.

3.5 idle characters	Slave address	Function code	Data	Error check CRC-16	3.5 idle characters
	8-bit	8-bit	* * bits	16-bit	

Master judges the transmission complete after no command for 4-characters idle time and process the command.

*Transmission speed and judgment time to complete transmission

Transmission speed (bps)	Judgment time to complete (ms)
38400	about 1.00
19200	about 2.00
9600	about 4.00
4800	about 8.00
2400	about 16.00

◇Slave address:

Slave address is an individual instrument number on the slave side and is set within the range 1 to 99 (01H to 63H). Master identifies slaves by the slave address of the requested message.

Slave informs master which slave is responding to master by placing its own address in the response message. Slave address 0 (00H, broadcast address) can identify all slaves connected. However slaves do not respond.

◇Function code: Function code is command code for the slave to undertake the following action types.

Function code	Contents
03(03H)	DT Read
06(06H)	DT1 word write
16(10H)	DT several data write

Function code is used to discern whether the response is normal (acknowledgement) or if any error (negative acknowledgement) has occurred when slave returns response message to master.

When acknowledgement is returned, slave simply returns original function code. When negative acknowledgement is returned, MSB of original function code is set as 1 for response.

For example, when the master sends request message setting 00H to function code by mistake, slave returns 80H by setting MSB to 1, because the former is an illegal function.

For negative acknowledgement, the exception codes below are set to data of response message and returned to master in order to inform it of what kind of error has occurred.

Exception code	Contents
1(01H)	Illegal Function (Non-existent function)
3(03H)	Illegal data value (Value out of the device numbers)

note1) Even if it commands to write (06H.10H) to non-existent data address, slave response with acknowledgement. However, it doesn't write.

note2) Even if it commands to write the value out of the setting range, slave response with acknowledgement. However, it doesn't write.

note3) The maximum number of reading slaves is 26 (57-bite), the maximum number of writing slaves is 23 (55-bite).

◇Data: Data depends on the function code.

A request message from the master side is composed of data item, number of data and setting data.

A response message from the slave side is composed of number of bytes, data and exception code in negative acknowledgement.

◇Error check: 16-bit data to detect communication errors. Refer to the next.

◇Acknowledgement response

When command is to write 1 point, same message of command is responded.

When command is to write several points, part of command message (6-bite) is responded.

◆Error check

After calculating CRC-16 (Cyclic Redundancy Check) from slave address to the end of data, the calculated 16-bit data is appended to the end of message in sequence from low order to high order.

<How to calculate CRC>

In CRC system, the information is divided by the polynomial series. The remainder is added to the end of the information and transmitted. The generation of polynomial series is as follows.

(Generation of polynomial series: $X^{16} + X^{15} + X^2 + 1$)

- ① Initialize the CRC-16 data (assumed as X) (FFFFH).
- ② Calculate exclusive OR (XOR) with the 1st data and X. This is assumed as X.
- ③ Shift X one bit to the right. This is assumed as X.
- ④ When a carry is generated as a result of the shift, XOR is calculated by X of ③ and the fixed value (A001H). This is assumed as X. If a carry is not generated, go to step ⑤.
- ⑤ Repeat steps ③ and ④ until shifting 8 times.
- ⑥ XOR is calculated with the next data and X. This is assumed as X.
- ⑦ Repeat steps ③ to ⑤.
- ⑧ Repeat steps ③ to ⑤ up to the last data.
- ⑨ Set X as CRC-16 to the end of message in sequence from low order to high order.

◆Message example

① Reading electricity rate (0036H) of address 1

•Command

3.5 idle characters	Slave address (01H)	Function code (03H)	Data item (0036H)	Number of data (0001H)	Error check CRC-16 (6404H)	3.5 idle characters
	1	1	2	2	2	←character number

•Response message from slave in normal status (When Rate=1000(10.00) [03E8H])

3.5 idle characters	Slave address (01H)	Function code (03H)	Number of response byte (02H)	Number of data (03E8H)	Error check CRC-16 (B8FAH)	3.5 idle characters
	1	1	1	2	2	←character number

② Setting electricity rate (0036H) of address 1 (When rate is set to 20.00(2000) [07D0H])

•Command

3.5 idle characters	Slave address (01H)	Function code (06H)	Data item (0036H)	Number of data (07D0H)	Error check CRC-16 (6A68H)	3.5 idle characters
	1	1	2	2	2	←character number

•Response message from slave in normal status

3.5 idle characters	Slave address (01H)	Function code (06H)	Data item (0036H)	Number of data (07D0H)	Error check CRC-16 (6A68H)	3.5 idle characters
	1	1	2	2	2	←character number

③ Reset integrated electric power (0064H, 0065H:2-word) of address 1
 (When setting to 0 [0000, 0000H])

• Command

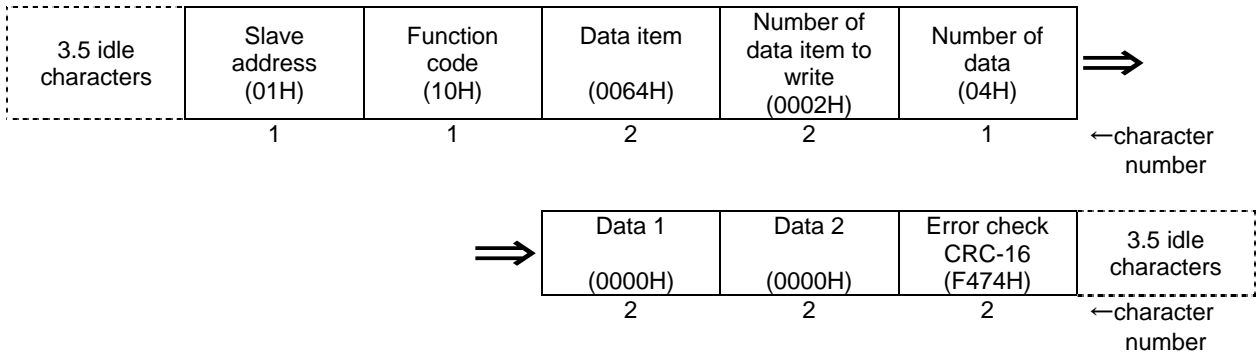

• Response message from slave in normal status

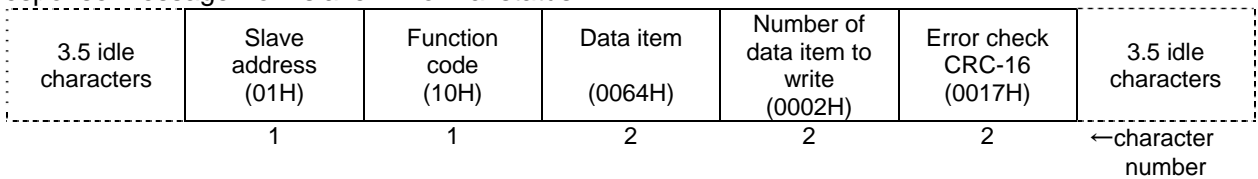

• A response message from the slave in exception (error) status

(When number of data has been mistaken.)

Function code MSB is set to 1 for the response message in exception (error) status (90H).
 The exception code 03H (Value out of the device numbers) is returned as contents of error.

<Mistaken message example (Command)>

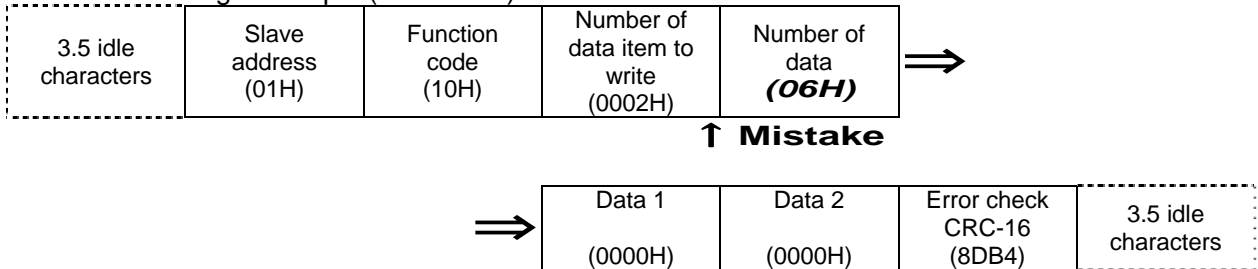

<Response message from slave to mistaken command
 (Response message in exception (error) status)>

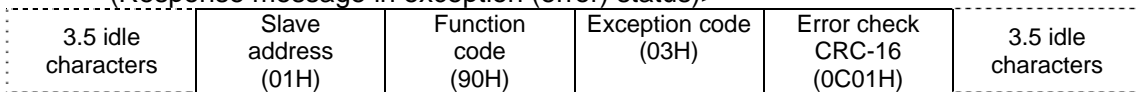

7.4.2 Data Register List (MODBUS communication)

【M】:Main unit 【E *】:Expansion unit Registers without 【 】 are common.

Data item (MEWTOCOL)	Name	Unit	Kind of data	Range: Hexadecimal (Range: Decimal)	MODBUS Function code
0014H (DT00020)	【M】CT type	Rated A (rms)	Unsigned 16bit	6 types: 5H(5),32H(50),64H(100), FAH(250),190H(400), 258H(600)	03H/ 06H/10H
0015H (DT00021)	【E1】CT type	Rated A (rms)	Unsigned 16bit		
0016H (DT00022)	【E2】CT type	Rated A (rms)	Unsigned 16bit		
0017H (DT00023)	【E3】CT type	Rated A (rms)	Unsigned 16bit		
0018H (DT00024)	【E4】CT type	Rated A (rms)	Unsigned 16bit		
0019H (DT00025)	【E5】CT type	Rated A (rms)	Unsigned 16bit		
001AH (DT00026)	【E6】CT type	Rated A (rms)	Unsigned 16bit		
001BH (DT00027)	【E7】CT type	Rated A (rms)	Unsigned 16bit		
001EH (DT00030)	【M】 Cutoff current	0.10%	Unsigned 16bit	1H to 1F4H (1 to 500)	03H/ 06H/10H
001FH (DT00031)	【E1】 Cutoff current	0.10%	Unsigned 16bit		
0020H (DT00032)	【E2】 Cutoff current	0.10%	Unsigned 16bit		
0021H (DT00033)	【E3】 Cutoff current	0.10%	Unsigned 16bit		
0022H (DT00034)	【E4】 Cutoff current	0.10%	Unsigned 16bit		
0023H (DT00035)	【E5】 Cutoff current	0.10%	Unsigned 16bit		
0024H (DT00036)	【E6】 Cutoff current	0.10%	Unsigned 16bit		
0025H (DT00037)	【E7】 Cutoff current	0.10%	Unsigned 16bit		
0028H (DT00040)	【M】Primary side current value when CT 5A	1A	Unsigned 16bit	1H to FA0H (1 to 4000)	03H/ 06H/10H
0029H (DT00041)	【E1】Primary side current value when CT 5A	1A	Unsigned 16bit		
002AH (DT00042)	【E2】Primary side current value when CT 5A	1A	Unsigned 16bit		
002BH (DT00043)	【E3】Primary side current value when CT 5A	1A	Unsigned 16bit		
002CH (DT00044)	【E4】Primary side current value when CT 5A	1A	Unsigned 16bit		
002DH (DT00045)	【E5】Primary side current value when CT 5A	1A	Unsigned 16bit		
002EH (DT00046)	【E6】Primary side current value when CT 5A	1A	Unsigned 16bit		
002FH (DT00047)	【E7】Primary side current value when CT 5A	1A	Unsigned 16bit		
0036H (DT00054)	Rate (CHG)	0.01	Unsigned 16bit	0H to 270FH (0 to 9999)	03H/ 06H/10H
0037H (DT00055)	Conversion factor (CO2)	0.001 kg-CO ₂	Unsigned 16bit	0H to 270FH (0 to 9999)	03H/ 06H/10H

Data item (MEWTOCOL)	Name	Unit	Kind of data	Range: Hexadecimal (Range: Decimal)	MODBUS Function code		
0038H (DT00056)	Simple measuring	—	Unsigned 16bit	0H(0):OFF 1H(1):ON	03H/ 06H/10H		
0039H (DT00057)	Simple voltage	0.1V	Unsigned 32bit	0H to 1869FH (0 to 99999)	03H/ 06H/10H		
003AH (DT00058)							
003BH (DT00059)	Simple PF	0.01	Unsigned 16bit	0H to 64H (0 to 100)	03H/ 06H/10H		
003DH (DT00061)	Unit for Pulse output	—	Unsigned 32bit	1H(1)<0.001>, AH(10)<0.01>, 64H(100)<0.1>, 3E8H(1000)<1>, 2710H(10000)<10>, 186A0H(100000)<100>, 3E7H(999) < Instantaneous electric power: Values of 0040H,0041H> 309H(777) < Ratio for current alarm: Value of 0045H> 22BH(555) < Preset value for output: Values of 009EH,009FH> 14DH(333) < Ratio and time for Stand-by alarm: Value of 004DH,004EH>	03H/ 06H/10H		
003EH (DT00062)							
0040H (DT00064)	Power alarm value (Instantaneous electric power)	0.01kW	Unsigned 32bit	0H to F423FH (0 to 999999)	03H/ 06H/10H		
0041H (DT00065)							
0042H (DT00066)	VT ratio	0.01	Unsigned 16bit	64H to 270FH (100 to 9999)	03H/ 06H/10H		
0044H (DT00068)	Cutoff current	0.1%	Unsigned 16bit	1H to 1F4H (1 to 500)	03H/ 06H/10H		
0045H (DT00069)	Ratio for current alarm	0.1%	Unsigned 16bit	1H to 3E8H (1 to 1000)	03H/ 06H/10H		
0046H (DT00070)	Voltage range	—	Unsigned 16bit	2H(2); 200V <Fixed>	03H		
004DH (DT00077)	Ratio for stand-by current	0.1%	Unsigned 16bit	1H to 3E8H (1 to 1000)	03H/ 06H/10H		
004EH (DT00078)	Time for stand-by alarm	1min	Unsigned 16bit	0H to 270FH (0 to 9999)	03H/ 06H/10H		
0056H Upper (DT00086)	【M】Shift average frequency	—	Unsigned 16bit	5 types: 0H(0),2H(2),4H(4),8H(8), 10H(16)	03H/ 06H/10H		
0056H Lower (DT00086)	【E1】Shift average frequency						
0057H Upper (DT00087)	【E2】Shift average frequency	—	Unsigned 16bit				
0057H Lower (DT00087)	【E3】Shift average frequency						
0058H Upper (DT00088)	【E4】Shift average frequency	—	Unsigned 16bit				
0058H Lower (DT00088)	【E5】Shift average frequency						
0059H Upper (DT00089)	【E6】Shift average frequency	—	Unsigned 16bit				
0059H Lower (DT00089)	【E7】Shift average frequency						
009EH (DT00158)	Preset value	—	Unsigned 32bit			0H to F423FH (0 to 999999)	03H/ 06H/10H
009FH (DT00159)							

Data item (MEWTOCOL)	Name	Unit	Kind of data	Range: Hexadecimal (Range: Decimal)	MODBUS Function code
00A0H (DT00160)	Prescale value	0.001	Unsigned 32bit	1H to 186A0H (1 to 100000)	03H/ 06H/10H
00A1H (DT00161)					
00A2H (DT00162)	Max. counting speed	Hz	Unsigned 16bit	C350H (50000) , 1EH (30)	03H/ 06H/10H
00A3H (DT00163)	Auto-off time	min	Unsigned 16bit	0H to 63H (0 to 99)	03H/ 06H/10H

Measurement value

Data item (MEWTOCOL)	Name	Unit	Kind of data	Range: Hexadecimal (Range: Decimal)	MODBUS Function code
0064H (DT00100)	【M】 Integrated active power ((1))	0.01kWh	Unsigned 32bit	0H to 3B9AC9FFH (0 to 99999999)	03H/ 06H/10H
0065H (DT00101)					
006FH (DT00111)	【M】Power factor ((1))	0.01	Signed 16bit	FF9CH to 0064H (-100 to 100)	03H
0070H (DT00112)	Frequency	0.1Hz	Unsigned 16bit	0H to 3E8H (0 to 1000)	03H
0071H (DT00113)	【M】Power factor (2) * 1	0.01	Signed 16bit	FF9CH to 0064H (-100 to 100)	03H
0078H (DT00120)	【M】 Integrated active power ((1))	0.01kWh	Unsigned 32bit	0H to 3B9AC9FFH (0 to 99999999)	03H/ 06H/10H
0079H (DT00121)					
007AH (DT00122)	【M】 Integrated active power(2) * 1	0.01kWh	Unsigned 32bit	0H to 3B9AC9FFH (0 to 99999999)	03H/ 06H/10H
007BH (DT00123)					
007CH (DT00124)	【M】 Voltage (R/RS)	0.1V	Unsigned 32bit	0H to F423FH (0 to 999999)	03H
007DH (DT00125)					
007EH (DT00126)	【M】 Voltage (RT)	0.1V	Unsigned 32bit	0H to F423FH (0 to 999999)	03H
007FH (DT00127)					
0080H (DT00128)	【M】 Voltage (T/TS) * 1	0.1V	Unsigned 32bit	0H to F423FH (0 to 999999)	03H
0081H (DT00129)					
0086H (DT00134)	【M】 Current (R)	0.001A	Unsigned 32bit	0H to 5B8D80H (0 to 6000000)	03H
0087H (DT00135)					
0088H (DT00136)	【M】 Current (N/S)	0.001A	Unsigned 32bit	0H to 5B8D80H (0 to 6000000)	03H
0089H (DT00137)					
008AH (DT00138)	【M】 Current (T) * 1	0.001A	Unsigned 32bit	0H to 5B8D80H (0 to 6000000)	03H
008BH (DT00139)					
008CH (DT00140)	【M】 Instantaneous active power ((1))	0.0001 kW (0.1W)	Signed 32bit	FF676981H to 98967FH (-9999999 to 9999999)	03H
008DH (DT00141)					
008EH (DT00142)	【M】 Instantaneous active power(2) * 1	0.0001 kW (0.1W)	Signed 32bit	FF676981H to 98967FH (-9999999 to 9999999)	03H
008FH (DT00143)					

Data item (MEWTOCOL)	Name	Unit	Kind of data	Range: Hexadecimal (Range: Decimal)	MODBUS Function code
009AH (DT00154)	Pulse count value	—	Unsigned 32bit	0H to F423FH (0 to 999999)	03H
009BH (DT00155)					
00AAH (DT00170)	【M】 Voltage (R/RS)	0.1V	Unsigned 32bit	0H to F423FH (0 to 999999)	03H
00ABH (DT00171)					
00ACH (DT00172)	【M】 Voltage (ST)	0.1V	Unsigned 32bit	0H to F423FH (0 to 999999)	03H
00ADH (DT00173)					
00AEH (DT00174)	【M】 Voltage (T/TS) * 1	0.1V	Unsigned 32bit	0H to F423FH (0 to 999999)	03H
00AFH (DT00175)					
00B0H (DT00176)	【M】 Instantaneous active power ((1))	0.01 kW	Signed 32bit	FF0BDC1H to F423FH (-999999 to 999999)	03H
00B1H (DT00177)					
00B2H (DT00178)	【M】 Instantaneous reactive power ((1))	0.01 kvar	Signed 32bit	FF0BDC1H to F423FH (-999999 to 999999)	03H
00B3H (DT00179)					
00B4H (DT00180)	【M】 Instantaneous apparent power ((1))	0.01 kVA	Unsigned 32bit	0H to F423FH (0 to 999999)	03H
00B5H (DT00181)					
00B6H (DT00182)	【M】 Instantaneous active power(2) * 1	0.01 kW	Signed 32bit	FF0BDC1H to F423FH (-999999 to 999999)	03H
00B7H (DT00183)					
00B8H (DT00184)	【M】 Instantaneous reactive power(2) * 1	0.01 kvar	Signed 32bit	FF0BDC1H to F423FH (-999999 to 999999)	03H
00B9H (DT00185)					
00BAH (DT00186)	【M】 Instantaneous apparent power(2) * 1	0.01 kVA	Unsigned 32bit	0H to F423FH (0 to 999999)	03H
00BBH (DT00187)					

Data of 2nd circuit of single-phase two-wire system will be entered in name with * 1.
Refer to “Data Register List (MEWTOCOL)” about measuring data of expansion unit.

Chapter 8 How to update the firmware

8.1 Prepare Eco-POWER METER to update

- 1) Power off KW2G Eco-POWER METER main unit (including expansion unit).
- 2) With pressing 3 keys of <MODE>, <SET> and <ITEM/▲>, power on KW2G Eco-POWER METER.

After unit numbers and [PROG] are displayed on the upper line, release the keys.
Unit number [M] and [PROG] on the upper line and current version [xx.xx] are displayed.

This is ready to update the firmware of Eco-POWER METER.

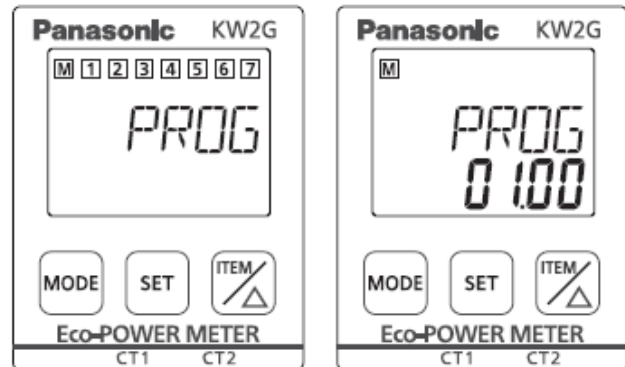

8.2 Update the firmware using KW Version Upgrade Tool

- 1) Start "KW Version Upgrade Tool".
Click [Version] and it displays the current version of connected units.
Check the boxes of unit number to update firmware.

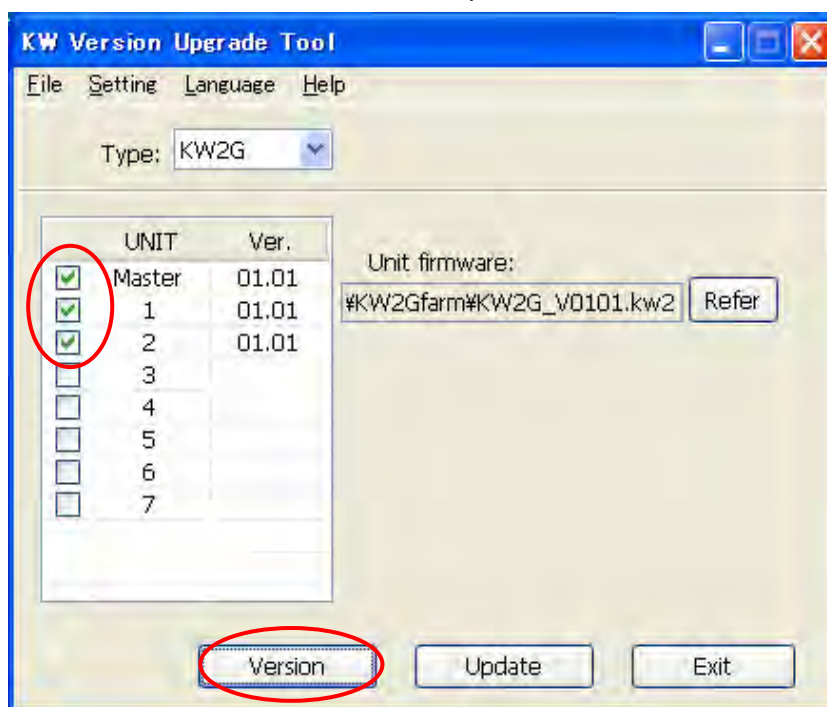

When timed out error is occurred, check the below.

- Is Eco-POWER METER ready to update?
- Is USB cable connected correctly?
- Are communication port and timeout value conformed?

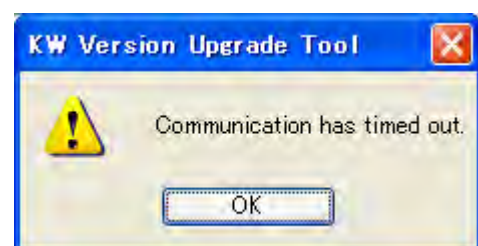

- 2) Click [Refer] and it opens the window to select firmware.
Select file to update "kw2gverxxx_verup.kw2" and click [Open].
*You can download from our website the latest firmware.

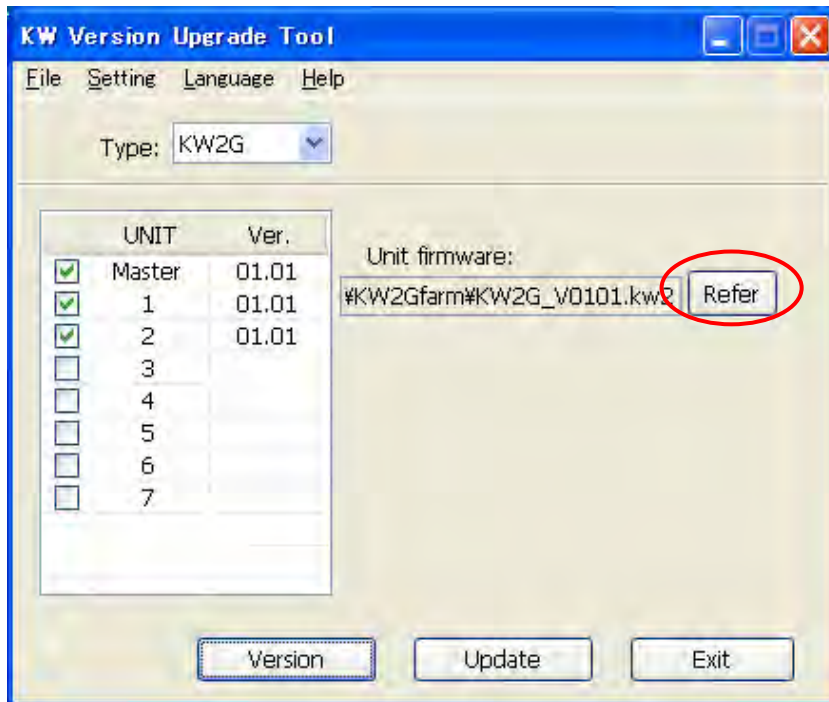

- 3) When selected file name is displayed, click [Update].

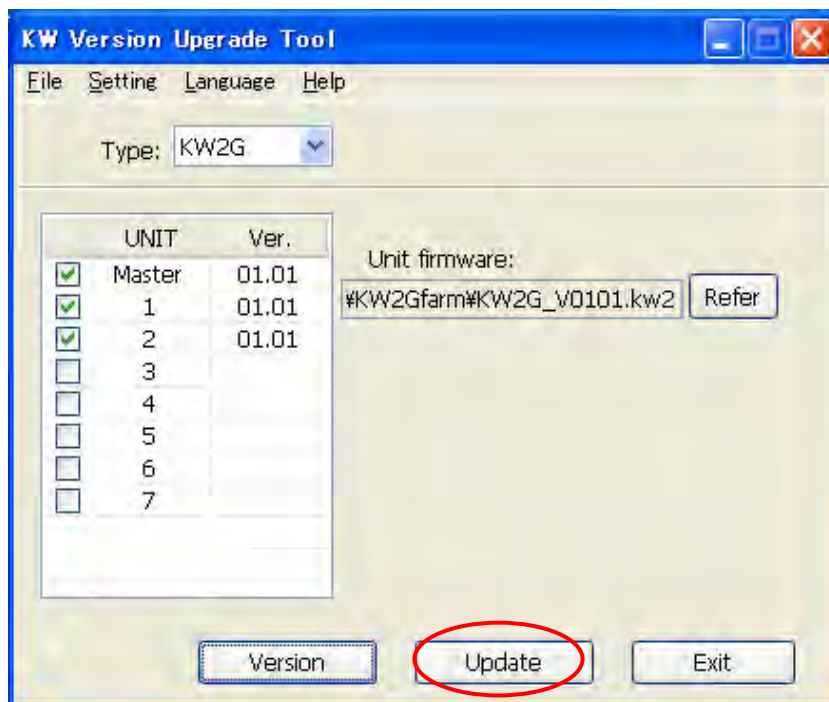

The firmware in Eco-POWER METER is same or newer version of selected firmware, the window to skip or not is appeared. When you don't update the firmware, click [Yes] to finish it.



When you have used KW Version Upgrade Tool before, it displays the last updated firmware. If the firmware was moved, the error window will be appeared. Select firmware again and update it.



4) When it starts updating, the indicator is appeared and it updates to the selected firmware.

[Display of Eco-POWER METER]

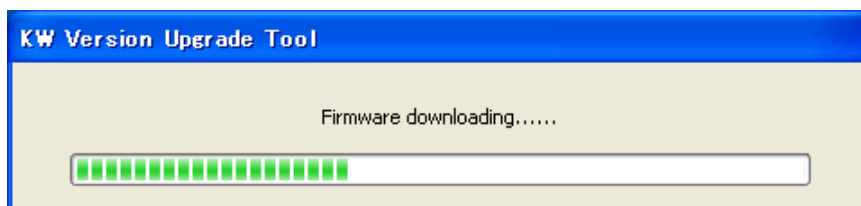

Do not turn off Eco-POWER METER.

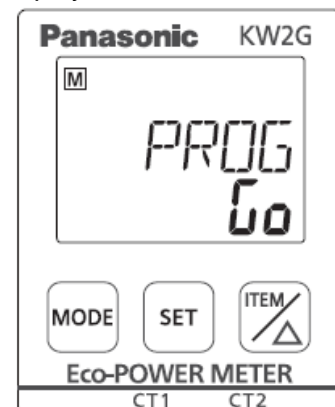

5) When it completes updating the firmware, the complete window will be appeared. Click [OK].

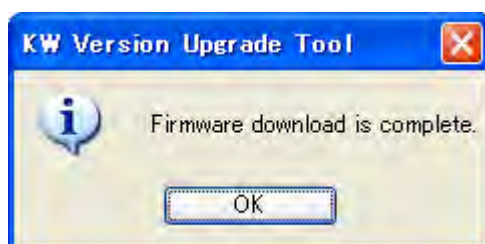

- 6) Cells of unit that its firmware is updated correctly are white.
 You can confirm with the display of Eco-POWER METER.
 After upgrading, [ROMV] is displayed on the upper line and version is displayed on the lower line.

[Display of Eco-POWER METER]

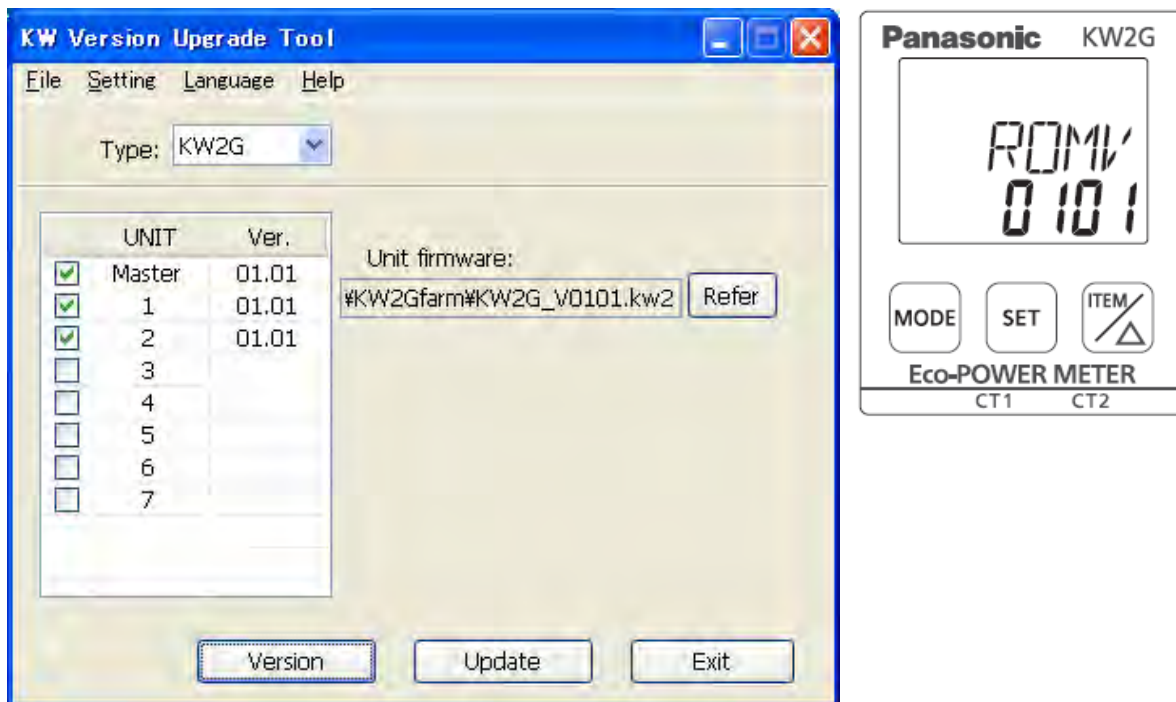

After completing download, cell of unit that its firmware is not updated, is yellow and cell of unit that updating is failure is red.

On the display of Eco-POWER METER, [PROG] is displayed on the upper line and [- - -] is displayed on the lower line.

Check and confirm the wiring of Eco-POWER METER and so on and update again.

[Display of Eco-POWER METER]

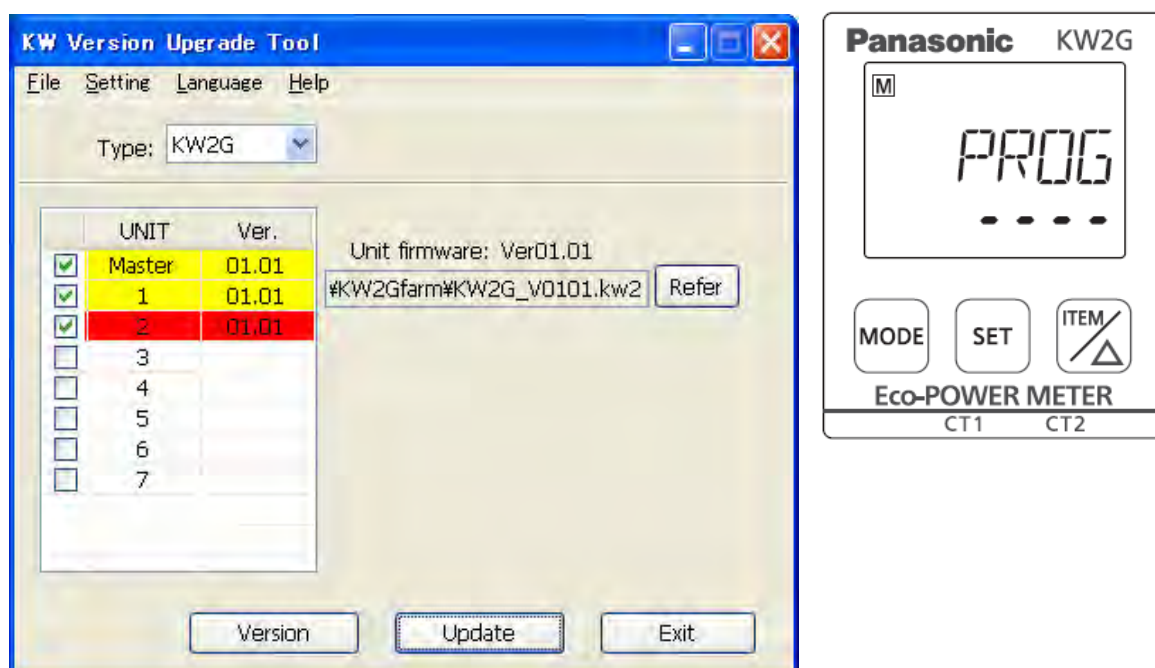

When click [Update] to update unit that update failed again, the below window might be appeared.
In this case, click [No] and update it.



- 7) Click [Exit] to close KW Version Upgrade Tool.
Power off KW2G Eco-POWER METER and turn on again.
After that you can use KW2G Eco-POWER METER.

Chapter 9 Specifications

9.1 Main unit, Expansion unit

Phase and wire system	Single-phase two-wire system, Single-phase three-wire system, (common) Three-phase three-wire system	
Rated operating voltage	100-240V AC (Add to main unit)	
Rated frequency	50/60Hz common	
Rated power consumption	Main unit: 6VA (15VA max.) Expansion unit: 0.5VA/unit (AC240V at 25°C)	
Inrush current	Max. 30A (AC240V at 25°C)	
Allowable operating voltage range	85-264V AC (85% to 110% of rated operating voltage)	
Allowable momentary power-off time	10ms	
Ambient temperature	-10 to +50°C (-25°C to +70°C at storage)	
Ambient humidity	30 to 85%RH (at 20°C non-condensing)	
Breakdown voltage(initial)	Between the isolated circuits: 1500V/1min Detective current: 10mA or less	A)Outer edge (case)— All terminals B)Between Insulated circuit •USB terminal— All other terminals •RS485— All other terminals •Pulse output terminals— All other terminals
Insulation resistance(initial)	Between the isolated circuits: 100MΩ or more (measured at 500V DC)	* Voltage input terminals are not insulated CT input terminals. * Voltage input terminals are not insulated pulse input terminals.
Vibration resistance	16.7Hz total amplitude (double amplitude):4mm (1h on 3 axes)	
Shock resistance	DIN rail mounting: Min. 294m/s ² (5 times on 3 axes)	
Display method	LCD with backlight (green) Upper: 5-digit (7-segment 1-digit+ 16-segment 4digit) letters' H::6.0mm Lower: 6-digit (7-segment) letter' H:6.5mm	
Connectable unit number	Max. 7	
Power failure Memory method	EEPROM (more than 100,000 overwrite) Memory items: Setting value, Measuring value	
Size	Main unit:50×95×65 mm, Expansion unit:25×95×65 mm	
Mounting method	DIN rail mounting	
Weight	Main unit: 180g, Expansion unit: 80g	

9.2 Measurement

● Electric power input

Phase and wire system		Single-phase two-wire system Single-phase three-wire system (common) Three-phase three-wire system
Measurement circuit	Main unit	1-circuit (When measuring 1P2W: 2-circuit)
	Expansion unit	1-circuit (When measuring 1P2W: 2-circuit)
Max. measurement circuit		8-circuit (When measuring 1P2W: 16-circuit) (One main unit +7 expansion units)
Input measurement Voltage	Rating	Single-phase two-wire system: 100-240V AC (Line voltage) Single-phase three-wire system: 100-120V AC (Phase voltage) Three-phase three-wire system: 100-240V AC (Line voltage)
	Allowable measurement voltage	85 to 110% of rated input voltage Single-phase two-wire system: 85-264V AC (Line voltage) Single-phase three-wire system: 85-132V AC (Phase voltage) Three-phase three-wire system: 85-264V AC (Line voltage)
	VT ratio	1.00 to 99.99 (Set with setting mode) *Voltage transformer (VT) is required when you measure a load with voltage over 240VAC (Allowable measurement voltage). *Secondary current rating of VT is 110V.
Input measurement Current	Rating	<Using the dedicated CT> •5A/50A/100A/250A/400A/600A (Select with setting mode) <Using a commercial CT with the secondary side current 5A> •1 to 4000A (Set with setting mode) *Use CT with secondary side current of 5A when measure 600A or more.
	Allowable measurement current	120% of rated input voltage
Special Functions	Cut-off current	0.1 to 50.0%F.S. (Set with setting mode)
	Cut-off voltage	Below 5% of rating voltage (Rating voltage x 0.05 x VT ratio) (Fixed)
Accuracy (without error in CT and VT)	Indication accuracy	Instantaneous electric power / Integrated electric power / Voltage / Current / Electricity charge / Conversion value $\pm(2.0\% \text{ F.S.} + 1 \text{ digit})$ (at 20°C, rated input, rated frequency, power factor 1) *Accuracy coverage: 10 to 100% of CT
	Current	$\pm(1.0\% \text{ F.S.} + 1 \text{ digit})$ (at 20°C, rated input, rated frequency, power factor 1) *Accuracy coverage: 10 to 100% of rated current
	Voltage	$\pm(1.0\% \text{ F.S.} + 1 \text{ digit})$ (at 20°C, rated input, rated frequency, power factor 1)
	Temperature characteristics	$\pm(1.0\% \text{ F.S.} + 1 \text{ digit})$ (Range of -10 to 50°C, rated input, power factor 1)
	Frequency characteristics	$\pm(1.0\% \text{ F.S.} + 1 \text{ digit})$ (Frequency change $\pm 5\%$ based on rated frequency for rated input, power factor 1)
Data update cycle		100ms

●Pulse input

Input method	Contact / non-voltage a contact or open-collector	
Insulation method	Non-isolated with internal circuit	
Input mode	Addition (Fixed)	
Max. counting speed	50kHz/30Hz (Select with setting mode)	
Pulse input	Min. input signal width: 0.01ms(When 50kHz selected)/ 16.7ms(When 30Hz selected) ON:OFF ratio = 1:1	
Input signal	Contact / No contact (open collector) • Impedance when shorted: Max. 1kΩ • Residual voltage when shorted: Max. 2V • Impedance when open: Min. 100kΩ	
Output mode	HOLD (Over count)	
Prescale	Decimal point	under 3-digit
	Range	0.001 to 100.000 (Set with setting mode)

<Circuit diagram>

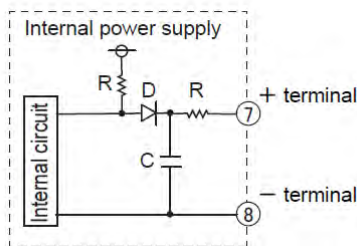

R: resistor
C: capacitor
D: diode

9.3 Output Specifications

●Pulse output (Transistor output)

Number of output point	1 point
Insulation method	Optical coupler
Output type	Open collector
Output capacity	100mA 30V DC
Pulse width (when pulse output with integrated electric power selected.)	approx. 100ms
ON state voltage drop	1.5V or less
OFF state leakage current	100 μ A or less
Pulse output unit	0.001/0.01/0.1/1/10/100kWh/Power alarm(AL-P)/ Current alarm(AL-C) /Stand-by alarm (AL-S) /Counter(Cnt) (Selectable with setting mode)

<Circuit diagram>

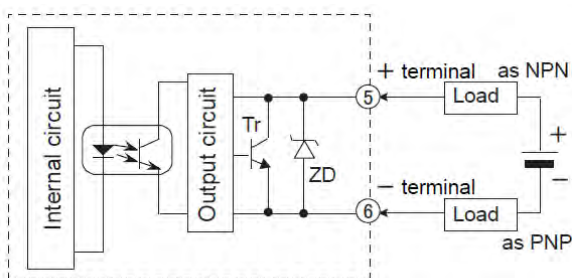

ZD:Zener diode for serge voltage abdor
Tr:NPN transistor

Note) Output circuit has no protection circuit for short.

* We recommend the setting of minimum unit for pulse output for measurement shown as below.
Output pulse: 4 pulses or less per 1sec.

How to calculate

(Unit for pulse output: PL-P) > (Max. measurement power [kW]) / (3600[s] × 4 [pulse/s])

- Note (1) Improper unit setting may cause miss counting.
 (2) If the OFF time is too short, there is a possibility of counting errors.

9.4 Communication Specifications

< RS485 >

Interface	Conforming to RS485		
Protocol	MEWTOCOL/MODBUS(RTU) (selectable with setting mode)		
Isolation status	Isolated with the internal circuit		
Number of connected units	99 (max.) ^{*2 *3}		
Transmission distance	1200m (max.) ^{*1}		
Transmission speed	38400/19200/9600/4800/2400bps (selectable with setting mode)		
Transmission Format	Data length	8bit/7bit (selectable with setting mode) ^{*4}	
	Parity	Not available / Odd number / Even number (selectable with setting mode)	
	Stop bit	1bit /2bit (selectable with setting mode)	
Communication method	Half-duplex		
Synchronous system	Synchronous communication method		
Ending resistance	approx. 120 Ω (built-in)		

*1 Please check with the actual devices when some commercial devices with RS485 interface are connected. The number of connected devices, transmission distance, and transmission speed may be different according to using transmission line.

*2 For RS485 converter on the computer side, we recommend SI-35 and SI-35USB (from LINE EYE Co.,Ltd.).

*3 When using SI-35,SI-35USB or PLC from our company (which can be connected up to 99 units), up to 99 Eco-POWER METER can be connected. In case using this system with the other devices, up to 31 Eco-POWER METER can be connected.

*4 With MODBUS (RTU) protocol, it works only with 8bit.

< USB >

Electric specification	Conform to USB2.0 standard		
Connector shape	USB series MiniB		
Insulation method	Insulated to internal circuit		
Transmission speed	12Mbps(Full-Speed)		
Transmission function	Computer link (MEWTOCOL)		

* Install the dedicated USB driver before using USB port.

(The USB driver is downloaded with KW Monitor (our free software) Download from our website. Customers' registration is required to download.)

9.5 Applicable standard

Safety standard	EN61010-1, EN61326-1		
EMC	EMI EN61326-1	Radiation interference field strength Noise terminal voltage	CISPR11 class A CISPR11 class A
	EMS EN61326-1	Static discharge immunity RF electromagnetic field immunity EFT/B immunity Surge immunity Conductivity noise immunity Power frequency magnetic field immunity Voltage dip / Instantaneous stop / Voltage fluctuation immunity	EN61000-4-2 EN61000-4-3 EN61000-4-4 EN61000-4-5 EN61000-4-6 EN61000-4-8 EN61000-4-11

9.6 Dedicated Current Transformer Specifications

Model No	AKW4801C	AKW4802C	AKW4803C	AKW4804C
Primary side rated current	5A / 50A	100A	250A	400A
Secondary side rated Current	1.67mA / 16.7mA	33.3mA	125mA	200mA
Winding (Turn)	3000	3000	2000	2000
Ratio error	±2.0% F.S.			
Hole Dia (mm)	φ 10	φ 16	φ 24	φ 36
Breakdown voltage(initial)	AC1000V/1min (Between through hole and output lead wire)		AC2000V/1min (Between through hole and output lead wire)	
Insulation resistance (initial)	Min. 100MΩ (at DC500V) (Between through hole and output lead wire)			
Vibration resistance	Functional	10 to 55Hz (1 cycle/ minute) single amplitude of 0.15mm (10 min. on X,Y and Z axes)		
	Destructive	10 to 55Hz (1 cycle/ minute) single amplitude of 0.375mm (1 hrs. on X,Y and Z axes)		
Shock resistance	Functional	Min. 98m/s ² (4 times on X,Y and Z axes)		
	Destructive	Min. 294m/ s ² (5 times on X,Y and Z axes)		
Output protection level	±7.5V with clamp element		±3.0V with clamp element	
Permissible clamping frequency	Approx. 100 times			
Ambient temperature	-10 to +50°C (without frost and non-condensing)			
Storage temperature	-20 to +60°C (without frost and non-condensing)			
Ambient humidity	35 to 80%RH (at 20°C non-condensing)			
Weight (with relay cable)	Approx. 60g	Approx. 85g	Approx. 215g	Approx. 315g

Note) Dedicated current transformers (CT), AKW4801C, 4802C, 4803C, 4804C, are dedicated for low voltage under 440V. They can not be used for high voltage circuit. In case measuring high voltage circuit, make a 2-step construction by combination of a commercial CT of secondary side current 5A for high voltage and the dedicated CT for 5A (AKW4801C).

9.7 Self-diagnostic function

If an error occurs, the following indication will be given.

Indicator	Meaning	Output status	To recover
Err0	CPU error	OFF	Turn the power off and then on again.
Err1	Memory error*		EEPROM life ended. Replace the unit.

*Includes the possibility that the EEPROM's life has expired.

9.8 Power Failure Memory

Eco-POWER METER memories integrated electric power and working status to internal EEPROM until when power supply is off. (Power failure guarantee)

And every time to change each setting, each setting value is memorized to internal EEPROM at the same time. Therefore, change setting frequently makes EEPROM's life short. Avoid to usage like this.

*Especially be careful if you set by communication.

Chapter 10 Mounting

10.1 Dimensions

(Unit:mm)
(tolerance:±1.0)

10.1.1 Main unit

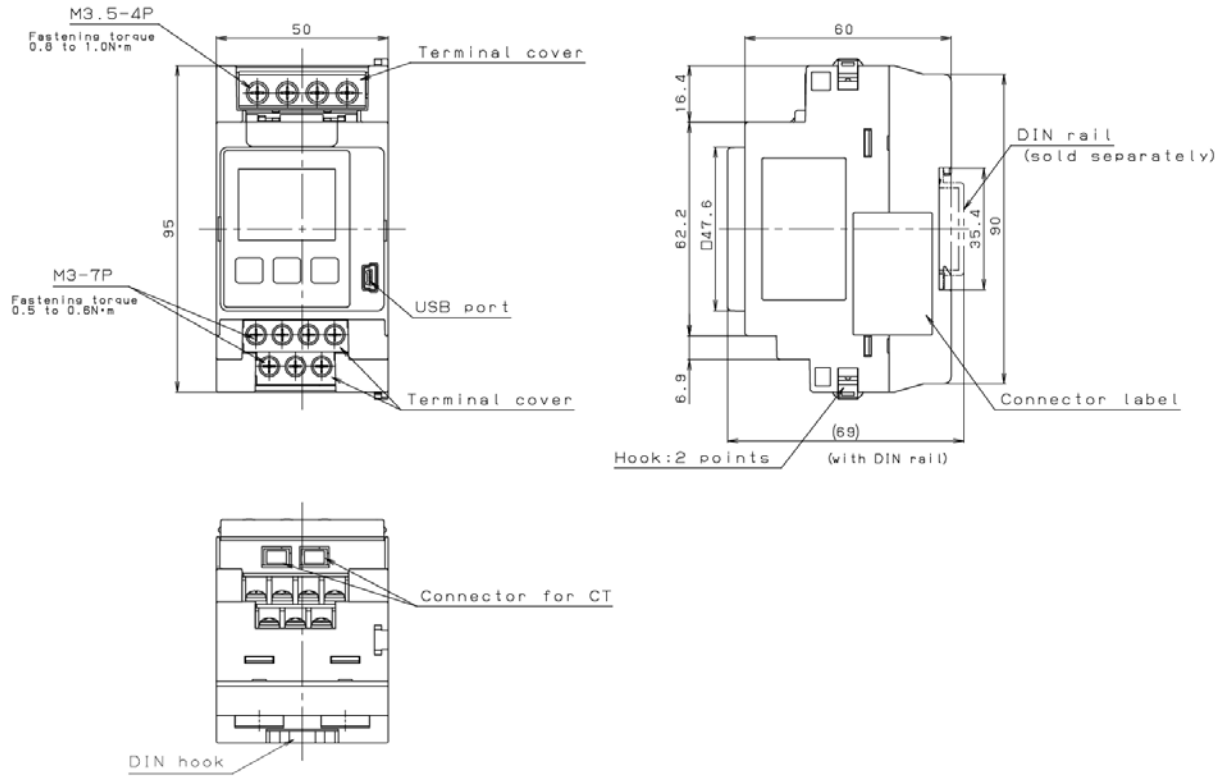

10.1.2 Expansion unit

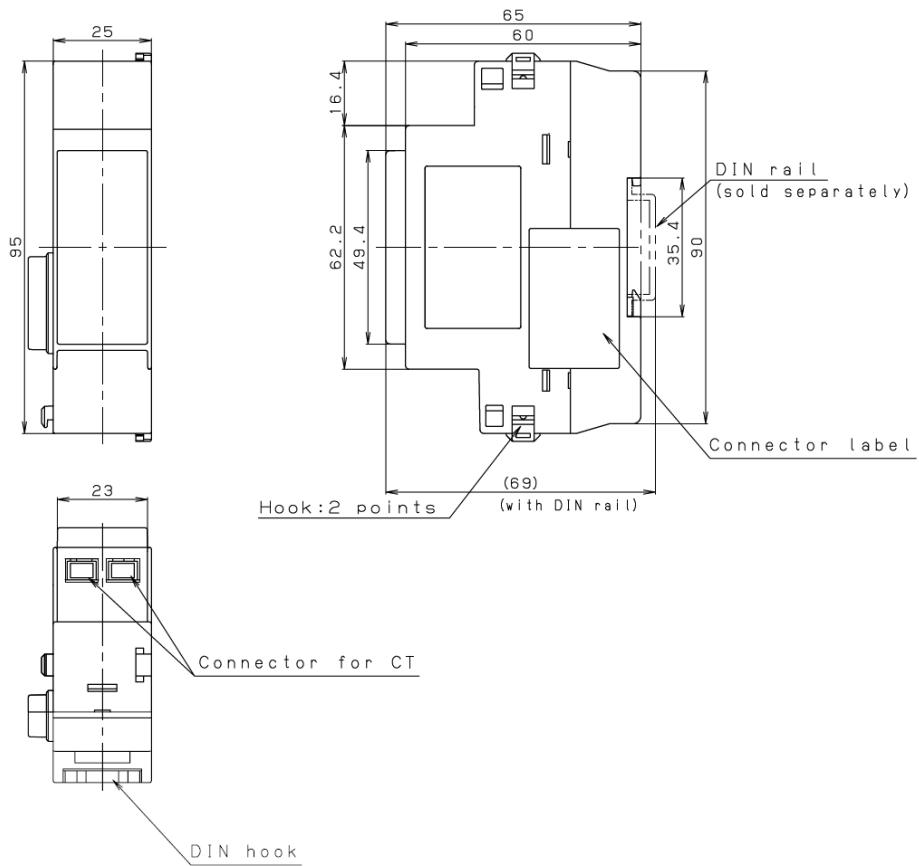

◆ DIN rail mounting

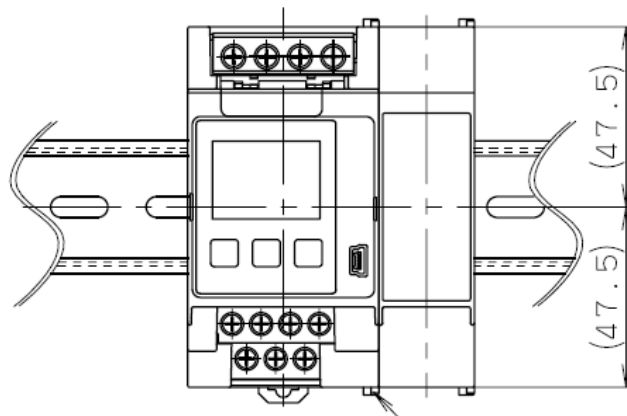

Be sure to fix by hooks when expanding.

◆ Panel cutout

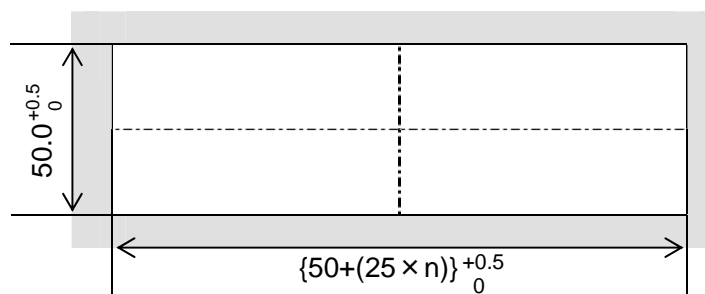

10.1.3 Dedicated CT

◆ For 5A/50A (AKW4801C)

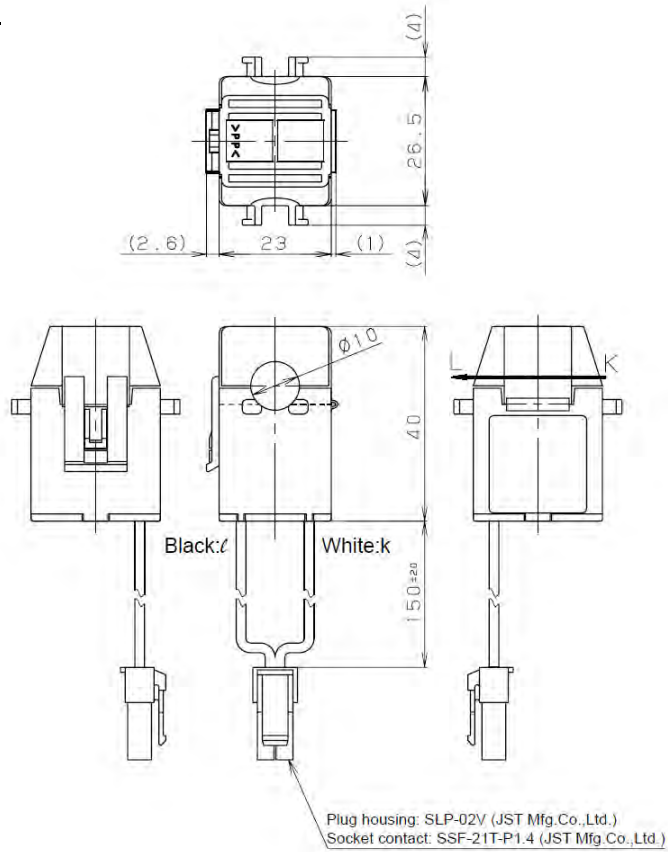

◆ For 100A (AKW4802C)

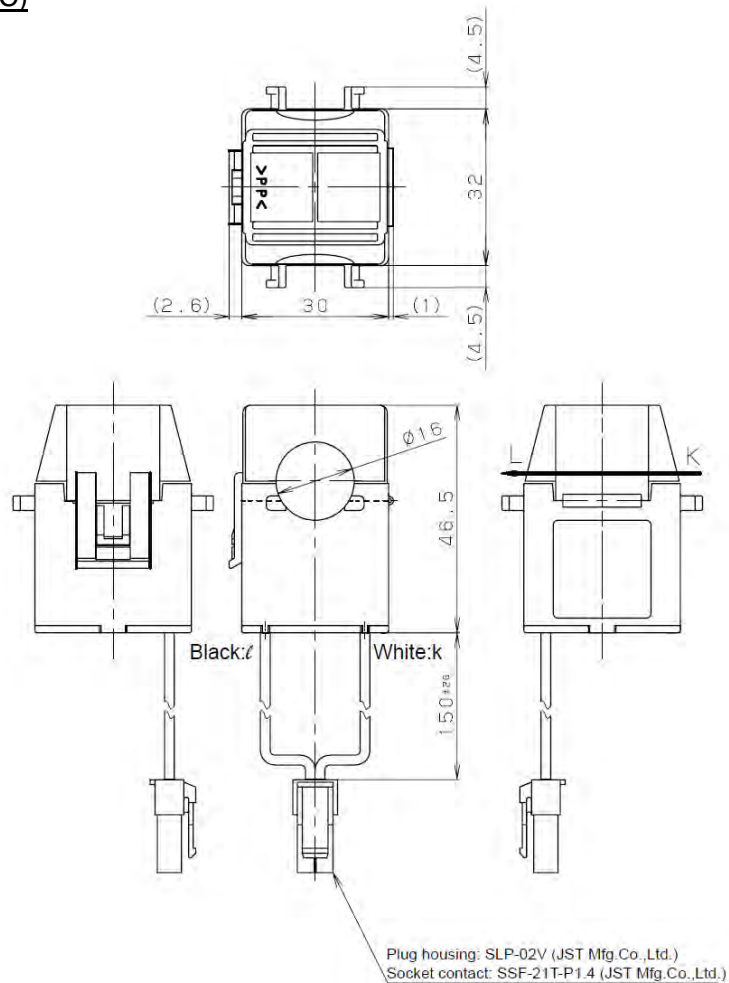

◆ For 250A (AKW4803C)

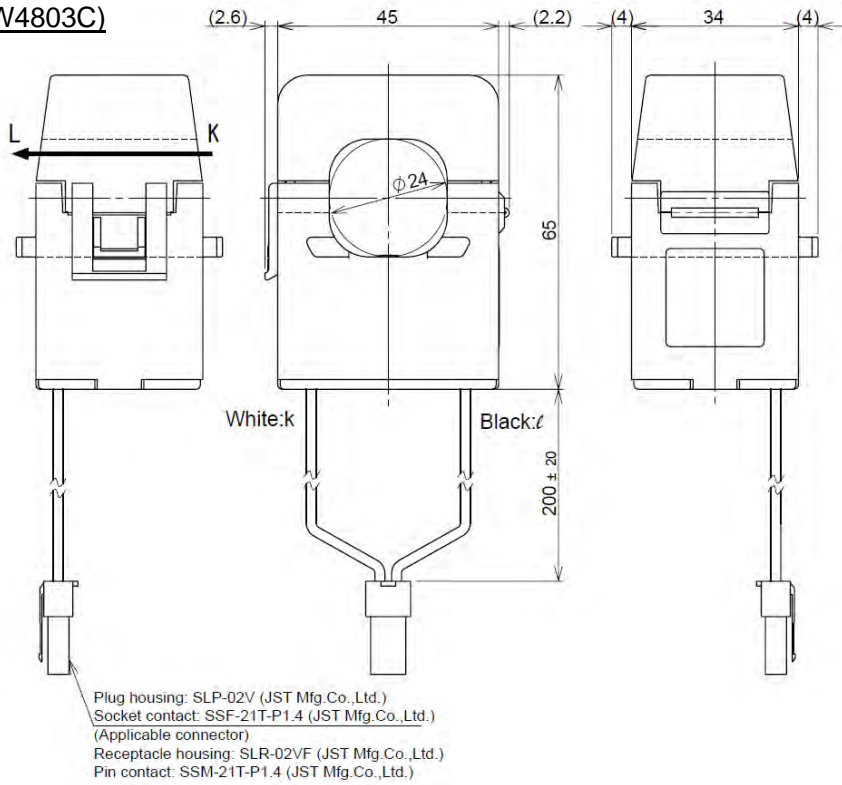

◆ For 400A (AKW4804C)

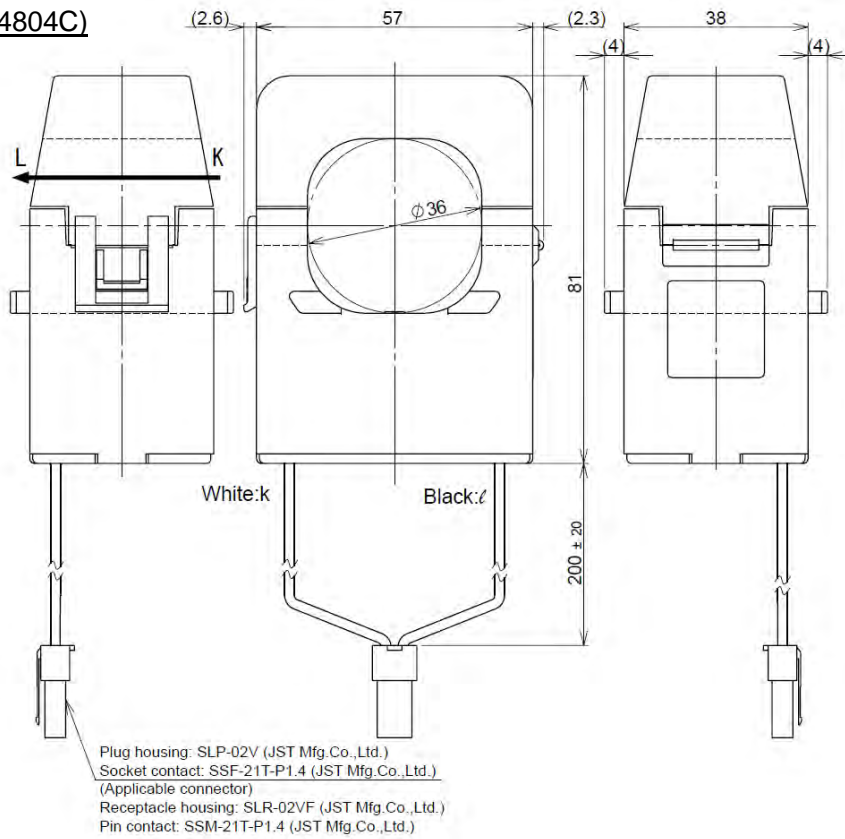

◆ Attached trunk cable (common)

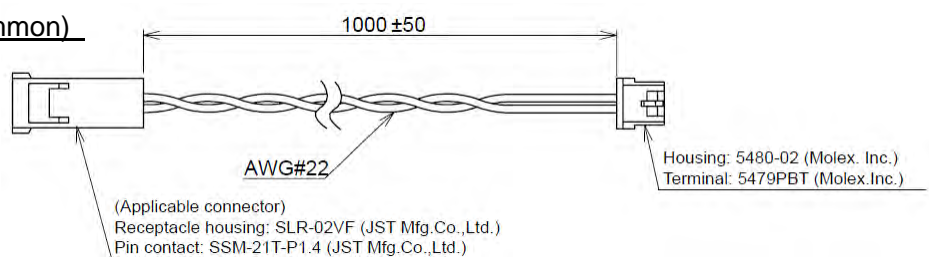

Revision History

Issue Date	Manual no.	Content of revision
August, 2011	ARCT1F520E	First edition

Please contact

Panasonic Electric Works SUNX Co., Ltd.

■ Head office: 2431-1 Ushiyama-cho, Kasugai-shi, Aichi, 486-0901, Japan

■ Telephone: +81-568-33-7861

■ Facsimile: +81-568-33-8591

panasonic-electric-works.net/sunx

All Rights Reserved © 2011 COPYRIGHT Panasonic Electric Works SUNX Co., Ltd.